

Whispering Pines No. 2
 Plat Cabinet "A" Slide 697-A

LUC Development, Inc.
 O.R. No. 70 P. 933 (9-13-1988)
 55-092-00-00-021.034
 15.123 Acres

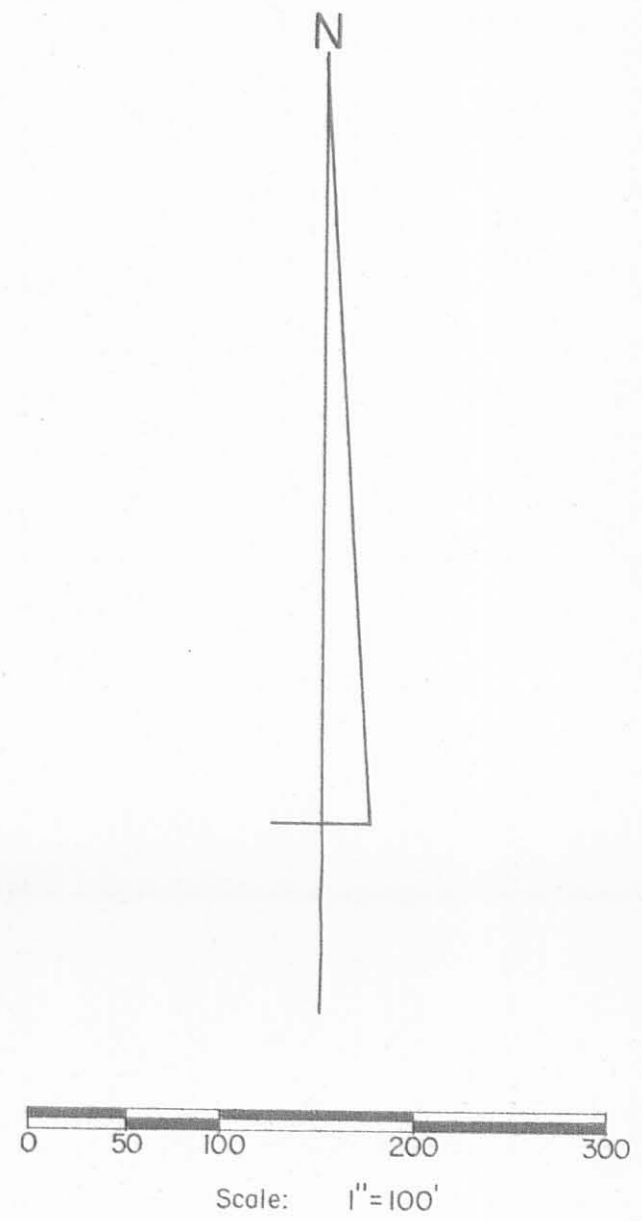

SYMBOLS:
 ● - R.R. Spikes Fd.
 ○ - R.R. Spikes Set.
 ✕ - 5/8" x 30" Rebars Fd.
 ✕ - 5/8" x 30" Rebars Set.
 □ - Iron Bolt Fd.

----- Existing Bellefontaine Corporation Line.

INDEXED ON MAP
 8738 1P

Boundary Survey of Belle Pines Allotment (Phase I).
 Virginia Military Surveys No's 3220 and 4788.
 City of Bellefontaine, Jefferson Township,
 Logan County, Ohio.

SCALE: 1" = 100'	APPROVED BY	DRAWN BY DEG
DATE: 5-14-1993		
Daniel E. Gilbert Daniel E. Gilbert, P.S. Reg. Sur. No. 5402.		DRAWING NUMBER 093-012

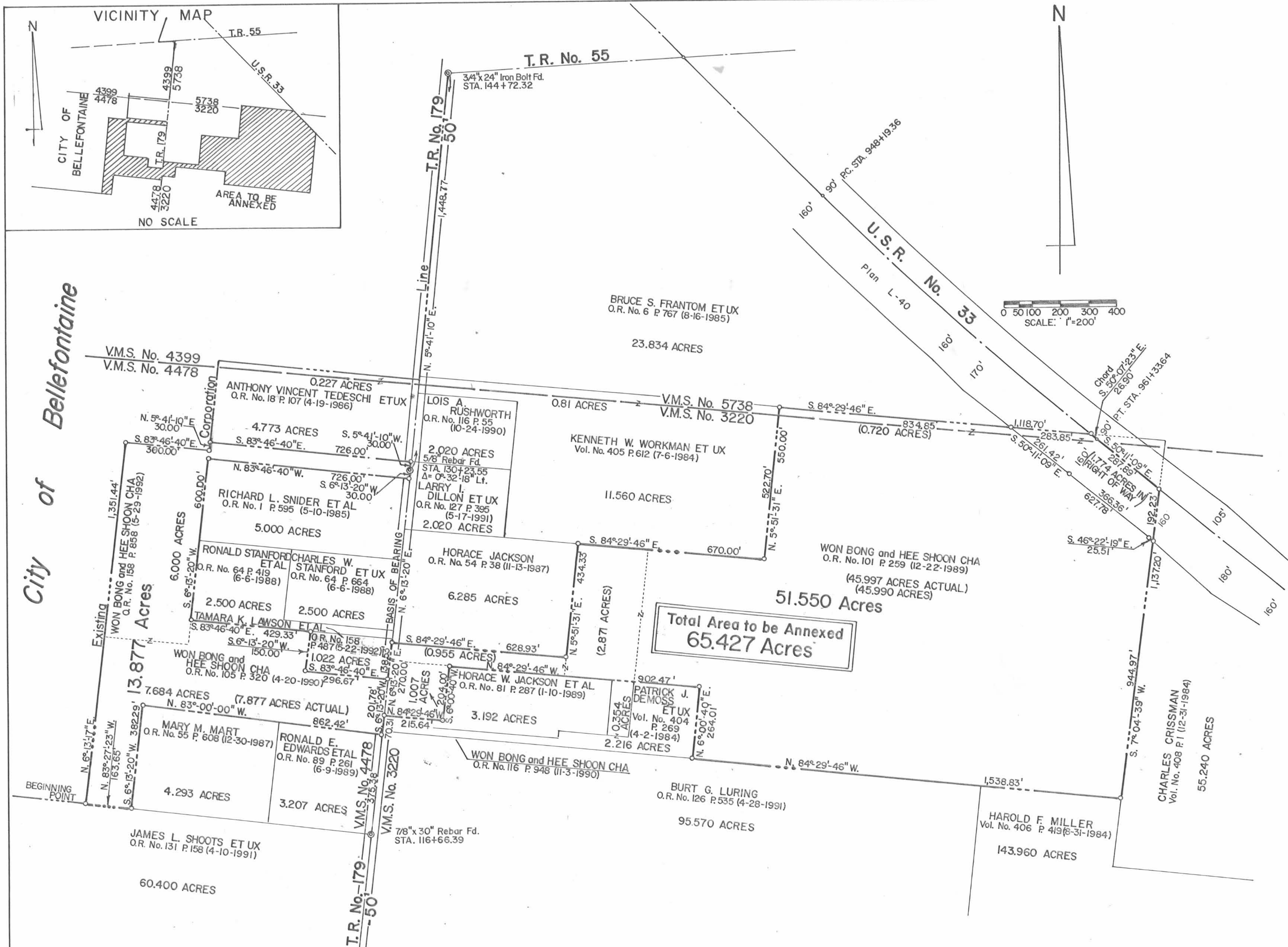

WON BONG CHA ANNEXATION MAP

Territory To Be Annexed To The City Of Bellefontaine
Located In V.M.S. No. 3220, V.M.S. No. 4478 And V.M.S. No. 5738
Jefferson Township, Logan County, Ohio

THE FOLLOWING DESCRIBED REAL ESTATE SITUATED IN THE TOWNSHIP OF JEFFERSON, COUNTY OF LOGAN, STATE OF OHIO AND BEING A PART OF V.M.S. NO. 3220, V.M.S. NO. 4478 AND V.M.S. NO. 5738 AND BEING THOSE TRACTS IN THE NAME OF WON BONG CHA AND HEE SHOON CHA, HUSBAND AND WIFE AS RECORDED IN O.R. NO. 101 P. 259 (12-22-1989)-50,536 ACRES, O.R. NO. 105 P. 320 (4-20-1990)-7,684 ACRES, O.R. NO. 116 P. 948 (11-3-1990)-1,007 ACRES AND O.R. NO. 159 P. 858 (5-29-1992)-6,000 ACRES, LOGAN COUNTY RECORDERS OFFICE AND BEING MORE PARTICULARLY DESCRIBED AS FOLLOWS:

BEGINNING AT AN ANGLE POINT IN THE PRESENT CITY OF BELLEFONTAINE CORPORATION LINE AT THE SOUTHWEST CORNER TO WON BONG CHA'S PRESENT 7,684 ACRE TRACT, O.R. NO. 105 P. 320 (4-20-1990) AND IN THE NORTH LINE OF JAMES L. SHOOTS' PRESENT 60,400 ACRE TRACT, O.R. NO. 131 P. 158 (4-10-1991);
 THENCE WITH THE PRESENT CORPORATION LINE AND THE WEST LINE OF CHA'S 7,684 ACRE TRACT AND CHA'S PRESENT 6,000 ACRE TRACT, O.R. NO. 159 P. 858 (5-29-1992), N. 6°-13'-20" W. 1,351.44 FEET TO THE NORTHWEST CORNER OF CHA'S 6,000 ACRE TRACT AND AN ANGLE POINT IN SAID CORPORATION LINE;
 THENCE WITH THE PRESENT CORPORATION LINE AND A NORTH LINE TO CHA'S 6,000 ACRE TRACT, S. 83°-46'-40" E. 300.00 FEET TO AN ANGLE POINT IN SAID CORPORATION LINE;
 THENCE CONTINUING WITH SAID CORPORATION LINE AND A WEST LINE OF CHA'S TRACT, N. 5°-41'-10" E. 30.00 FEET TO THE SOUTH-WEST CORNER OF ANTHONY VINCENT TEDESCHI'S PRESENT 5,000 ACRE TRACT, O.R. NO. 18 P. 107 (4-19-1986);
 THENCE WITH TEDESCHI'S SOUTH LINE, S. 83°-46'-40" E. 726.00 FEET TO THE CENTERLINE OF T.R. NO. 179, AT THE SOUTH-EAST CORNER TO TEDESCHI'S TRACT;
 THENCE WITH THE CENTERLINE OF T.R. NO. 179, S. 5°-41'-10" W. 30.00 FEET TO AN ANGLE IN SAID ROAD;
 THENCE AGAIN WITH THE CENTERLINE OF T.R. NO. 179, S. 6°-13'-20" W. 30.00 FEET TO THE NORTHEAST CORNER TO RICHARD L. SNIDER'S PRESENT 5,000 ACRE TRACT, O.R. NO. 1 P. 595 (5-10-1985);
 THENCE WITH SNIDER'S NORTH LINE, N. 83°-46'-40" W. 726.00 FEET TO SNIDER'S NORTHWEST CORNER;
 THENCE WITH SNIDER'S WEST LINE AND THE WEST LINE OF RONALD STANFORD'S PRESENT 2,500 ACRE TRACT, O.R. NO. 64 P. 419 (6-6-1988), S. 6°-13'-20" W. 600.00 FEET TO STANFORD'S SOUTHWEST CORNER;
 THENCE WITH STANFORD'S SOUTH LINE, S. 83°-46'-40" E. 429.33 FEET TO THE NORTHWEST CORNER TO TAMARA K. LAWSON'S PRESENT 1,022 ACRE TRACT, O.R. NO. 158 P. 487 (6-22-1992);
 THENCE WITH LAWSON'S WEST LINE, S. 6°-13'-20" W. 150.00 FEET TO LAWSON'S SOUTHWEST CORNER;
 THENCE WITH LAWSON'S SOUTH LINE, S. 83°-46'-40" E. 296.67 FEET TO THE CENTERLINE OF T.R. NO. 179 AT THE SOUTHEAST TO LAWSON'S TRACT;
 THENCE WITH THE CENTERLINE OF T.R. NO. 179, N. 6°-13'-20" E. 138.53 FEET TO THE SOUTHWEST CORNER TO HORACE JACKSON'S PRESENT 6,285 ACRE TRACT, O.R. NO. 54 P. 38 (11-13-1987), (NOTE: THE CENTERLINE OF T.R. NO. 179 IS THE BASIS OF BEARING FOR THIS DESCRIPTION - N. 6°-13'-20" E.);
 THENCE WITH JACKSON'S SOUTH LINE, S. 84°-29'-46" E. 628.93 FEET TO JACKSON'S SOUTHEAST CORNER;
 THENCE WITH JACKSON'S EAST LINE, N. 5°-51'-31" E. 434.33 FEET TO JACKSON'S NORTHEAST CORNER IN THE SOUTH LINE OF KENNETH W. WORKMAN'S PRESENT 11,560 ACRE TRACT, VOL. NO. 405 P. 612 (7-6-1984);
 THENCE WITH WORKMAN'S SOUTH LINE, S. 84°-29'-46" E. 670.00 FEET TO WORKMAN'S SOUTHEAST CORNER;
 THENCE WITH WORKMAN'S EAST LINE, N. 5°-51'-31" E. 550.00 FEET TO THE NORTHEAST CORNER TO WORKMAN'S TRACT AND IN THE SOUTH LINE OF BRUCE S. FRANTOM'S PRESENT 23,834 ACRE TRACT, O.R. NO. 6 P. 767 (8-16-1985), PASSING THROUGH THE LINE BETWEEN V.M.S. NO. 3220 AND V.M.S. NO. 5738 AT 522.70 FEET;
 THENCE WITH FRANTOM'S SOUTH LINE, S. 84°-29'-46" E. 1,118.70 FEET TO THE CENTERLINE OF U.S.R. NO. 33 ON A CURVE TO THE LEFT, HAVING A RADIUS OF 12,277.67 FEET, PASSING THROUGH THE WEST RIGHT OF WAY LINE AT 834.85 FEET;
 THENCE WITH CENTERLINE OF U.S.R. NO. 33 ON SAID CURVE, WITH A CHORD, S. 50°-07'-23" E. 26.90 FEET TO THE POINT OF TANGENCY;
 THENCE CONTINUING WITH THE CENTERLINE OF U.S.R. NO. 33, S. 50°-11'-09" E. 287.89 FEET TO THE WEST LINE OF CHARLES CRISSMAN'S PRESENT 55,240 ACRE TRACT, VOL. NO. 408 P. 1 (12-31-1984);
 THENCE WITH CRISSMAN'S WEST LINE, S. 7°-04'-39" W. 1,137.20 FEET TO A NORTHEAST CORNER TO HAROLD F. MILLER'S PRESENT 143,960 ACRE TRACT, VOL. NO. 406 P. 419 (6-31-1984), PASSING THROUGH THE WEST RIGHT OF WAY LINE AT 192.23 FEET;
 THENCE WITH MILLER'S NORTH LINE AND THE NORTH LINE OF BURT G. LURING'S PRESENT 95,570 ACRE TRACT, O.R. NO. 126 P. 535 (4-28-1991), N. 84°-29'-46" W. 1,538.83 FEET TO THE SOUTHEAST CORNER TO PATRICK J. DEMOSS' PRESENT 2,216 ACRE TRACT, VOL. NO. 404 P. 269 (4-2-1984);
 THENCE WITH DEMOSS' EAST LINE, N. 6°-00'-40" E. 264.01 FEET TO THE NORTHEAST CORNER TO DEMOSS;
 THENCE WITH DEMOSS' NORTH LINE AND THE NORTH LINE OF HORACE W. JACKSON'S PRESENT 3,192 ACRE TRACT, O.R. NO. 81 P. 287 (1-10-1989), N. 84°-29'-46" W. 902.47 FEET TO A NORTHWEST CORNER TO JACKSON'S TRACT;
 THENCE WITH A WEST LINE OF JACKSON'S TRACT, S. 6°-00'-40" W. 204.00 FEET TO A CORNER TO JACKSON'S TRACT;
 THENCE WITH A NORTH LINE OF JACKSON'S TRACT, N. 84°-29'-46" W. 215.64 FEET TO THE CENTERLINE OF T.R. NO. 179 AT A NORTHWEST CORNER TO JACKSON'S TRACT;
 THENCE WITH THE CENTERLINE OF T.R. NO. 179, S. 6°-13'-20" W. 70.31 FEET TO THE NORTHEAST CORNER TO RONALD E. EDWARDS' PRESENT 3,207 ACRE TRACT, O.R. NO. 89 P. 261 (6-9-1989);
 THENCE WITH THE NORTH LINE OF EDWARDS' TRACT AND THE NORTH LINE OF MARY M. MART'S PRESENT 4,293 ACRE TRACT, O.R. NO. 55 P. 608 (12-30-1987), N. 83°-00'-00" W. 862.42 FEET TO MART'S NORTHWEST CORNER;
 THENCE WITH MART'S WEST LINE, S. 6°-13'-20" W. 382.29 FEET TO MART'S SOUTHWEST CORNER AND IN THE NORTH LINE OF JAMES L. SHOOTS' PRESENT 60,400 ACRE TRACT, O.R. NO. 131 P. 158 (4-10-1991);
 THENCE WITH SHOOTS' NORTH LINE, N. 83°-27'-23" W. 163.65 FEET TO THE PLACE OF BEGINNING, CONTAINING A TOTAL OF 65,427 ACRES, MORE OR LESS.

OF THE ABOVE DESCRIBED TRACT, THERE BEING 50,830 ACRES IN V.M.S. NO. 3220, 13,877 ACRES IN V.M.S. NO. 4478 AND 0,720 ACRES IN V.M.S. NO. 5738.
 ALSO, THERE BEING 0,305 ACRES IN THE RIGHT OF WAY OF T.R. NO. 179 AND 1,774 ACRES IN THE RIGHT OF WAY OF U.S.R. NO. 33.

--- PROPOSED CORPORATION LINE.
 - - - - - EXISTING CORPORATION LINE.

JEFFERSON TOWNSHIP TRUSTEES	
<i>John W. Winland</i>	3/19/93
TRUSTEES	DATE
Plat Preapproval <i>Jon C. Hines</i> 9-9-92	
Plat Approval <i>Jon C. Hines</i>	4-14-93
TRUSTEES	DATE

BELLEFONTAINE CITY OFFICES	
<i>James D. Neeky</i>	3-26-93
PLANNING COMMISSION PRESIDENT	DATE
<i>William R. Patterson</i>	3/23/93
PRESIDENT OF COUNCIL	DATE
<i>Andythe Predmore</i>	3/23/93
CLERK OF COUNCIL	DATE
92-105	10-27-92
ORDINANCE NO. 1	DATE
<i>Richard J. Vicario</i>	3-23-93
MAYOR	DATE
<i>Felix L. N...</i>	3/25/93
CITY ENGINEER	DATE

LOGAN COUNTY OFFICES	
<i>Carmen K. Scott</i>	3-19-93
LUC REGIONAL PLANNING COMMISSION	DATE
<i>James G...</i>	4-1-93
LOGAN COUNTY ENGINEER	DATE
LOGAN COUNTY COMMISSIONERS	
<i>Donald C. Sawyer</i>	10-29-92
<i>George W. Clayton</i>	10-29-92

TRANSFERRED:	
Transferred this 18 th day of June, 1993.	
<i>Jean Jones</i>	Logan County Auditor
RECORDED:	
Recorded in Plat Cabinet A Slide 759A.	
Received for record at 2:41 O'Clock P.M.	
This 24 th day of June, 1993.	
<i>Carolyn Collins</i>	Logan County Recorder

This ANNEXATION MAP represents an area of land that has been researched and compiled by me from available recorded deeds, plats and other records on file in the Logan County Engineers Office, Logan County Recorders Office and City of Bellefontaine records.

I hereby certify this map is a correct representation of those records. Prepared August 27, 1992.

Daniel E. Gilbert
 Daniel E. Gilbert, P.S.
 Reg. Sur. No. 5402
 400 N. Park St.
 Bellefontaine, Ohio 43311
 Phone: (615) 593-1428

092-048

Lee Surveying and Mapping Co., Inc.

Land Surveys • Topography • Subdivisions • Construction Layout

117 N. Madriver St.
Bellefontaine OH 43311



Phone: (937) 593-7335
Fax: (937) 593-7444

CHA 50.714 ACRES

Lying in Virginia Military Survey 5738 and 3220, City of Bellefontaine, Jefferson Township, Logan County, Ohio.

Being all of the remainder of the Won Bong Cha and Hee Shoon Cha original 50.536 acre tract, Tract IV and all the remainder of the 1.007 acre tract, Tract III as deeded and described in Official Record 252, Page 973 of the Logan County Records of Deeds and being more particularly described as follows:

Beginning at a railroad spike found at the intersection with the center-line of Township Road 179 (60 feet wide) and the south line of Virginia Military Survey 5738.

THENCE, with the center-line of Township Road 179, S 6°-13'-20"W, a distance of 957.74 feet to a railroad spike found at THE TRUE POINT OF BEGINNING.

THENCE, with the south line of the John J. Rutledge and Joann H. Rutledge 2.169 acre tract (O.R. 318, Pg. 363), S 84°-28'-36"E, a distance of 629.26 feet to a 5/8 inch iron rod found, passing a 5/8 inch iron rod set at 30.00 feet.

THENCE, with the east lines of the John J. Rutledge and Joann H. Rutledge 2.169 acre tract (O.R. 318, Pg. 363), John J. Rutledge and Joann H. Rutledge 2.169 acre tract (O.R. 318, Pg. 365), John J. Rutledge and Joann H. Rutledge 1.943 acre tract (O.R. 318, Pg. 361), N 5°-57'-29"E, a distance of 433.44 feet to a 5/8 inch iron rod found.

THENCE, with the south line of the Robert A. Powell and Gretchen J. Powell 12.370 acre tract (O.R. 692, Pg. 628), S 84°-32'-19"E, a distance of 669.71 feet to a 5/8 inch iron rod found.

THENCE, with the east line of the said 12.370 acre tract, N 5°-49'-17"E, a distance of 550.06 feet to a 5/8 inch iron rod found.

THENCE, with the south line of the Bruce S. Frantom and Terry L. Frantom original 23.834 acre tract (O.R. 6, Pg. 767), S 84°-30'-13"E, a distance of 1118.70 feet to a point, passing a 5/8 inch iron rod found at 834.99 feet.

THENCE, with the center-line of U.S. Highway 33, with a curve to the right having a central angle of 0°-07'-43", a radius of 12277.67 feet, an arc length of 27.53 feet, a chord bearing of S 49°-41'-10"E, a distance of 27.53 feet to a point.

THENCE, with the center-line of U.S. Highway 33, S 50°-08'-57"E, a distance of 287.89 feet to a point.

THENCE, with the west line of the Charles Crissman 55.24 acre tract (Vol. 408, Pg. 1), S 7°-06'-51"W, a distance of 1137.20 feet to a 5/8 inch iron rod found, passing a 5/8 inch iron rod found at 192.03 feet.

THENCE, with the north line of the Harold F. Miller original 143.960 acre tract (Vol. 406, Pg. 419) and with the north line of the Ellen C. Cathey 98.216 acre tract (O.R. 580, Pg. 761), N 84°-27'-27"W, a distance of 1538.79 feet to a 5/8 inch iron rod found.

THENCE, with the east line of the Matthew D. Watkins and Rebecca L. Watkins 2.571 acre tract (O.R. 301, Pg. 204), N 5°-58'-30"E, a distance of 264.11 feet to 5/8 inch iron rod found.

THENCE, with the north line of said 2.571 acre tract and the north line of the Terry D. Maynard 3.192 acre tract (O.R. 440, Pg. 916), N 84°-30'-24"W, a distance of 902.34 feet to a 5/8 inch iron rod found, passing a 5/8 inch iron rod found at 487.35 feet.

Lee Surveying and Mapping Co., Inc.

Land Surveys • Topography • Subdivisions • Construction Layout

117 N. Madriver St.
Bellefontaine OH 43311



Phone: (937) 593-7335
Fax: (937) 593-7444

THENCE, with the west line of the said 3.192 acre tract, S 5°-53'-53"W, a distance of 113.95 feet to a 5/8 inch iron rod found.

THENCE, with the north line of the David Wisniewski and Laura Wisniewski 0.445 acre tract (O.R. 390, Pg. 744), N 84°-29'-05"W, a distance of 79.99 feet to a 5/8 inch iron rod found.

THENCE, with the east line of the Glenn E. Hill and Angela D. Hill 0.371 acre tract (O.R. 581, Pg. 177), N 5°-50'-39"E, a distance of 119.98 feet to a 5/8 inch iron rod found, passing a 5/8 inch iron rod set at 113.90 feet.

THENCE, with the north line of said 0.371 acre tract, N 84°-30'-32"W, a distance of 134.22 feet to a MAG nail found, passing a 5/8 inch iron rod found at 104.22 feet.

THENCE, with the center-line of Township Road 179, N 6°-13'-20"E, a distance of 60.00 feet to the point of beginning.

Containing 50.714 acres of which 1.831 acres are within the highway right-of-way.

Containing 49.984 acres in Virginia Military Survey 3220 of which 0.209 acre is the remainder of the 1.007 acre tract.

Containing 0.730 acre in Virginia Military Survey 5738.

The basis for bearings is the is the center-line of Township Road 179 being N 6°-13'-20"E, and all other bearings are from angles and distances measured in a field survey by Lee Surveying and Mapping Co., Inc. on February 17, 2004.



ORIGINAL STAMP IN GREEN

Description prepared by:

A handwritten signature in black ink, appearing to read 'Jeffrey I. Lee'.

Jeffrey I. Lee
Professional Surveyor 6359
February 24, 2004
Revised November 23, 2005

L-3757

CURVE	DELTA ANGLE	RADIUS	ARC	TANGENT	CHORD	CHORD BEARING
C 1	0° 07' 43"	12277.67'	27.53'	13.77'	27.53'	S 49° 41' 10" E

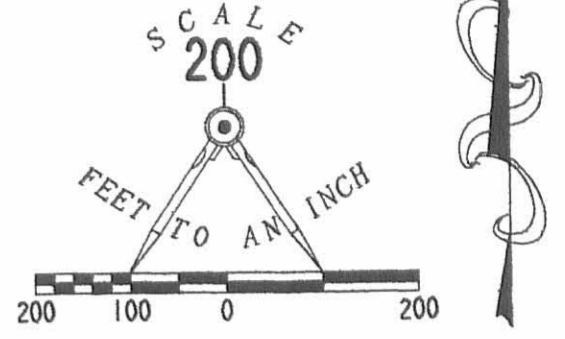

LEGEND

- 5/8 INCH IRON ROD FOUND
- ⊗ MAG NAIL FOUND
- ⊗ RAILROAD SPIKE FOUND
- 5/8 INCH IRON ROD SET

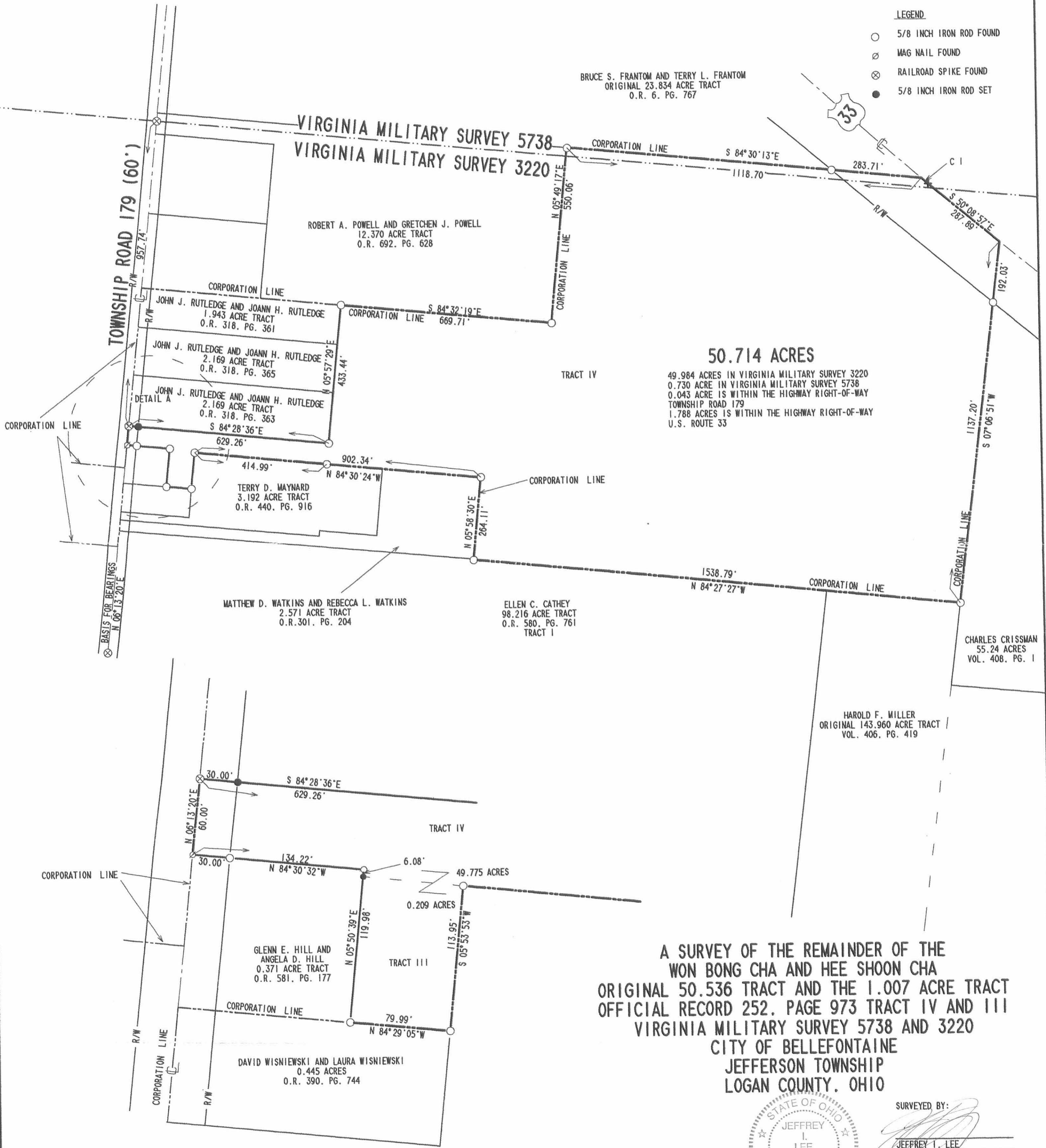

A SURVEY OF THE REMAINDER OF THE
WON BONG CHA AND HEE SHOON CHA
ORIGINAL 50.536 TRACT AND THE 1.007 ACRE TRACT
OFFICIAL RECORD 252, PAGE 973 TRACT IV AND III
VIRGINIA MILITARY SURVEY 5738 AND 3220
CITY OF BELLEFONTAINE
JEFFERSON TOWNSHIP
LOGAN COUNTY, OHIO

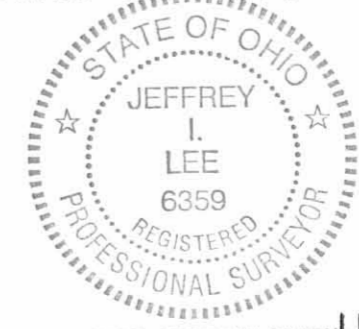

SURVEYED BY:
Jeffrey I. Lee
JEFFREY I. LEE
PROFESSIONAL SURVEYOR 6359
FEBRUARY 17, 2004
REVISED NOVEMBER 23, 2005

COPYRIGHT 2004 BY:
LEE SURVEYING & MAPPING CO., INC.
117 North Medriver Street
BELLEFONTAINE, OHIO 43311
(937) 593-7335

2 WORKING DAYS
BEFORE YOU DIG
CALL TOLL FREE **800-362-2764**
OHIO UTILITIES PROTECTION SERVICE

DETAIL A
4 X SCALE

REC'D 6-9-05 smy ok

Lee Surveying and Mapping Co., Inc.

Land Surveys • Topography • Subdivisions • Construction Layout

117 N. Madriver St.
Bellefontaine OH 43311

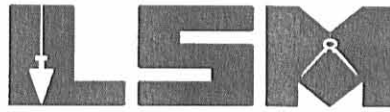

Phone: (937) 593-7335
Fax: (937) 593-7444

1975-2005 - 30 YEARS OF EXCELLENCE

**CHA
0.322 ACRE**

Lying in Virginia Military Survey 4478, City of Bellefontaine, Jefferson Township, Logan County, Ohio.

Being out of the Won Bong Cha and Hee Shoon Cha 6.000 acre tract as deeded and described in Official Record 252, Page 973, Tract II, part of Lots 4930 and 4931 of Belle Pines Subdivision (Plat Cabinet B, Slides 93A & 93b) of the Logan County Records of Deeds and being more particularly described as follows:

Beginning at a concrete monument set at the northwest corner of Lot 4930, on the east line of Lot 4999 of Whispering Pines No. 4 (Plat Cabinet B, Slide 43B, 44A & B).

THENCE, with the north lines of Lot 4930, Belle Pines Court and Lot 4931, S 83°-46'-40"E, a distance of 300.06 feet to a concrete monument set at the northeast corner of Lot 4931.

THENCE, with the east line of Lot 4931 and the west line of the Won Bong Cha 7.684 acre tract (O.R. 252, Pg. 973, Tract I), S 6°-13'-20"W, a distance of 46.82 feet to a 5/8 inch iron rod set.

THENCE, with the north line of the Won Bong Cha 0.207 acre tract (O.R. 729, Pg. 584), N 83°-46'-40"W, a distance of 300.05 feet to a 5/8 inch iron rod set.

THENCE, with the east line of Lot 5000 and Lot 4999 of Whispering Pines No. 4, N 6°-13'-03"E, a distance of 46.82 feet to the point of beginning.

Containing 0.322 acre.

The basis for bearings is the east line of Lot 5000, being N 6°-13'-03"E, and all other bearings are from angles and distances measured in a field survey by Lee Surveying and Mapping Co., Inc. on October 13, 2004.



ORIGINAL STAMP IN GREEN

Description prepared by:

Jeffrey I. Lee
Professional Surveyor 6359
June 8, 2005

L-3383

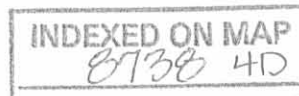

REC'D 6-9-05 S.M. OK

LEGEND:

- 5/8 INCH IRON ROD SET
- 5/8 INCH IRON ROD FOUND
- ⊕ CONCRETE MONUMENT SET

WON BONG CHA AND
HEE SHOON CHA
6.000 ACRES
O.R. 252, PG. 973
TRACT II

BELLEFONTAINE
CORPORATION
LINE

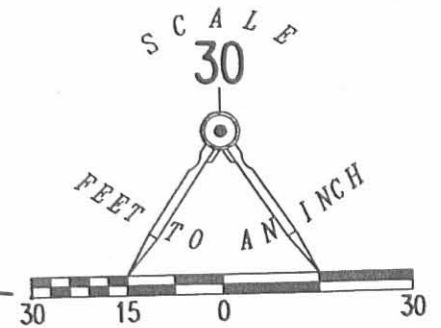

LOT 4999

LOT 4932

SURVEY OF A 0.322 ACRE TRACT
OUT OF THE
WON BONG CHA AND
HEE SHOON CHA
6.000 ACRE TRACT
OFFICIAL RECORD 252, PAGE 973
TRACT II

LOT 5000

WHISPERING PINES NO. 4
PLAT CABINET B, SLIDE 43B, 44A & B

LOT 4930

0.322 ACRE

LOT 4931

WON BONG CHA AND
HEE SHOON CHA
0.207 ACRE
O.R. 729, PG. 584

PART OF LOTS 4930 AND 4931
BELLE PINES SUBDIVISION
PLAT CABINET B, SLIDES 93A & 93B
VIRGINIA MILITARY SURVEY 4478
CITY OF BELLEFONTAINE
JEFFERSON TOWNSHIP
LOGAN COUNTY, OHIO

WON BONG CHA AND
HEE SHOON CHA
7.684 ACRES
O.R. 252, PG. 973
TRACT I

SURVEYED BY:

Jeffrey T. Lee
JEFFREY T. LEE
PROFESSIONAL SURVEYOR 6359
OCTOBER 13, 2004



ORIGINAL STAMP IN GREEN

COPYRIGHT 2005 BY:
LEE SURVEYING & MAPPING CO., INC.
117 North Madriver Street
BELLEFONTAINE, OHIO 43311
(937) 593-7335

KSR D0605 3383065 L-3383-3

WHITE PINES
DRIVE (60')

BELLE PINES SUBDIVISION
PLAT CABINET B, SLIDES 93A & 93B

WHITE PINES DRIVE (60')

LOT 5025

LOT 4929

LOT 4928

2 WORKING DAYS
BEFORE YOU DIG
CALL TOLL FREE 800-362-2764
OHIO UTILITIES PROTECTION SERVICE.

INDEXED ON MAP
0738 4P

REC'D 11-8-05 SWM OK

Lee Surveying and Mapping Co., Inc.

Land Surveys • Topography • Subdivisions • Construction Layout

117 N. Madriver St.
Bellefontaine OH 43311

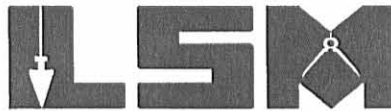

Phone: (937) 593-7335
Fax: (937) 593-7444

1975-2005 - 30 YEARS OF EXCELLENCE

**CHA
4.678 ACRES**

Lying in Virginia Military Survey 4478, City of Bellefontaine, Jefferson Township, Logan County, Ohio.

Being out of the Won Bong Cha and Hee Shoon Cha 6.000 acre tract as deeded and described in Official Record 252, Page 973, Tract II of the Logan County Records of Deeds and being more particularly described as follows:

Beginning at a concrete monument found at the northwest corner of Lot 4921 of Belle Pines Subdivision (Plat Cabinet B, Slide 93A and 93B), on the east line of Lot 4999 of Whispering Pines No. 4 (Plat Cabinet B, Slide 43B, 44A & B).

THENCE, with the east lines of Lots 4999, 4998, 4997, 4996, 4995, 4994 and 4993 of Whispering Pines No. 4 and Lots 4770 and 4769 of Whispering Pines No. 2 (Plat Cabinet A, Slides 697A-699A), N 6°-13'-03"E, a distance of 679.00 feet to a concrete monument set at the southwest corner of Lot 4766 of Whispering Pines No. 2.

THENCE, with the south lines of Lots 4766, 4765 and 4764 of Whipering Pines Subdivision No. 2, S 83°-46'-40"E, a distance of 300.11 feet to a concrete monument set.

THENCE, with the west line extended and the west lines of the Charles W. Stanford 5.000 acre tract (O.R. 490, Pg. 429), the Ronald E. Stanford 2.50 acre tract (O.R. 325, Pg. 701) and Lot 4923 of Belle Pines Subdivision, S 6°-13'-20"W, a distance of 679.00 feet to a concrete monument found, passing a concrete monument found at 630.03 feet.

THENCE, with the north lines Lot 4922, Belle Pines Court (60 feet wide) and Lot 4921 of Belle Pines Subdivision, N 83°-46'-40"W, a distance of 300.06 feet to the point of beginning.

Containing 4.678 acres.

The basis for bearings is the north line of Belle Pines Subdivision, being N 83°-46'-40"W, and all other bearings are from angles and distances measured in a field survey by Lee Surveying and Mapping Co., Inc. on June 15, 2005.



ORIGINAL STAMP IN GREEN

Description prepared by:

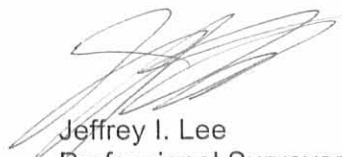
Jeffrey I. Lee
Professional Surveyor 6359
June 15, 2005

L-3383

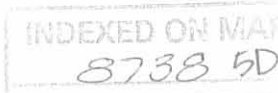

REC'D 11-8-05 SMJ/OK

BEFORE YOU DIG
CALL TOLL FREE 800-362-2764
OHIO UTILITIES PROTECTION SERVICE.

LEGEND:

- CONCRETE MONUMENT TO BE SET UPON COMPLETION OF CONSTRUCTION
- ⊙ CONCRETE MONUMENT FOUND

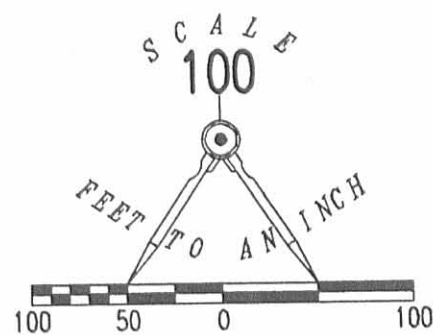

WHISPERING PINES NO. 2

PLAT CABINET A, SLIDES 697A-699A

WON BONG CHA AND
HEE SHOON CHA
ORIGINAL 6.000 ACRES
O.R. 252, PG. 973
TRACT II

CHARLES W. STANFORD
5.000 ACRES
O.R. 490, PG. 429

RONALD E. STANFORD
2.50 ACRES
O.R. 325, PG. 701

4.678 ACRES

WON BONG CHA AND
HEE SHOON CHA
ORIGINAL 6.000 ACRES
O.R. 252, PG. 973
TRACT II

WHISPERING PINES NO. 4
PLAT CABINET B, SLIDE 438, 44A & B

RED PINES DRIVE (60')

BELLE PINES COURT (60')

WHITE PINES DRIVE (60')

BELLE PINES SUBDIVISION
PLAT, CABINET B, SLIDES 93A & 93B

SURVEY OF 4.678 ACRES OUT OF THE
WON BONG CHA AND
HEE SHOON CHA
6.000 ACRE TRACT
OFFICIAL RECORD 252, PAGE 973
TRACT II
VIRGINIA MILITARY SURVEY 4478
CITY OF BELLEFONTAINE
JEFFERSON TOWNSHIP
LOGAN COUNTY, OHIO

INDEXED ON MAP
8738 5P



SURVEYED BY:
[Signature]
JEFFREY I. LEE
PROFESSIONAL SURVEYOR 6359
AUGUST 26, 2005, 2005

COPYRIGHT 2005 BY:
LEE SURVEYING & MAPPING CO., INC.
117 North Madriver Street
BELLEFONTAINE, OHIO 43311
(937) 593-7335

Lee Surveying and Mapping Co., Inc.

6-18-13



APPROVED

Land Surveys • Topography • Subdivisions • Construction Layout

117 N. Madriver St.
Bellefontaine OH 43311



Phone: (937) 593-7335
Fax: (937) 593-7444
surveys@lsminc.us

BELLE PINES SUBDIVISION LOT 5100 – TRACT B 0.124 ACRE

Lying in Virginia Military Survey 4478, City of Bellefontaine, Jefferson Township, Logan County, Ohio.

Being the south half of Lot 5100 of Belle Pines Subdivision Phase II as recorded in Plat Cabinet B, Slide 102A of the Logan County Records of Plats and being more particularly described as follows:

Beginning on a 5/8 inch iron rod found on the east right-of-way of Belle Pines Court (60 feet wide), also being the southwest corner of Lot 5100 and the northwest corner of Lot 5101.

THENCE, with the east right-of-way of Belle Pines Court, N 06°-13'-20"E, a distance of 45.00 feet to a 5/8 inch iron rod set.

THENCE, S 83°-46'-40"E, a distance of 120.05 feet to a 5/8 inch iron rod set.

THENCE, with the east line of Lot 5100 and the west line of the Ronald E. Stanford 2.50 acre tract (O.R. 325, Pg. 701), S 06°-13'-20"W, a distance of 45.00 feet to a 5/8 inch iron rod found on the southeast corner of Lot 5100 and the northeast corner of Lot 5101.

THENCE, with the south line of Lot 5100 and the north line of Lot 5101, N 83°-46'-40"W, a distance of 120.05 feet to the point of beginning.

Containing 0.124 acre.

Property is subject to any and all previous easements and rights-of-way of record.

The basis for bearings is the east right-of-way of Belle Pines Court, being N 06°-13'-20"E, and all other bearings are from angles and distances measured in a field survey by Lee Surveying and Mapping Co., Inc. on June 12, 2013.

Description prepared by:



William K. Bruce

William K. Bruce
Professional Surveyor 7437
June 12, 2013

33830513A

ORIGINAL STAMP IN GREEN

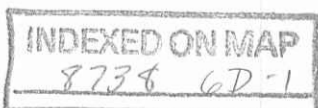

Lee Surveying and Mapping Co., Inc.

6-18-13



Land Surveys • Topography • Subdivisions • Construction Layout

117 N. Madriver St.
Bellefontaine OH 43311



Phone: (937) 593-7335
Fax: (937) 593-7444
surveys@lsminc.us

BELLE PINES SUBDIVISION LOT 5100 – TRACT A 0.124 ACRE

Lying in Virginia Military Survey 4478, City of Bellefontaine, Jefferson Township, Logan County, Ohio.

Being the north half of Lot 5100 of Belle Pines Subdivision Phase II as recorded in Plat Cabinet B, Slide 102A of the Logan County Records of Plats and being more particularly described as follows:

Beginning on a 5/8 inch iron rod found on the east right-of-way of Belle Pines Court (60 feet wide), also being the northwest corner of Lot 5100 and the southwest corner of Lot 5099.

THENCE, with the north line of Lot 5100 and the south line of Lot 5099, S 83°-46'-40"E, a distance of 120.05 feet to a 5/8 inch iron rod found on the northeast corner of Lot 5100 and the southeast corner of Lot 5099.

THENCE, with the east line of Lot 5100 and the west line of the Ronald E. Stanford 2.50 acre tract (O.R. 325, Pg. 701), S 06°-13'-20"W, a distance of 45.00 feet to a 5/8 inch iron rod set.

THENCE, N 83°-46'-40"W, a distance of 120.05 feet to a 5/8 inch iron rod set on the east right-of-way of Belle Pines Court.

THENCE, with the east right-of-way of Belle Pines Court, N 06°-13'-20"E, a distance of 45.00 feet to the point of beginning.

Containing 0.124 acre.

Property is subject to any and all previous easements and rights-of-way of record.

The basis for bearings is the east right-of-way of Belle Pines Court, being N 06°-13'-20"E, and all other bearings are from angles and distances measured in a field survey by Lee Surveying and Mapping Co., Inc. on June 12, 2013.



ORIGINAL STAMP IN GREEN

Description prepared by:

William K. Bruce
Professional Surveyor 7437
June 12, 2013

33830513A

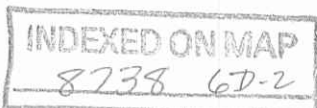

6-18-13

APPROVED

BELLE PINES COURT (60')

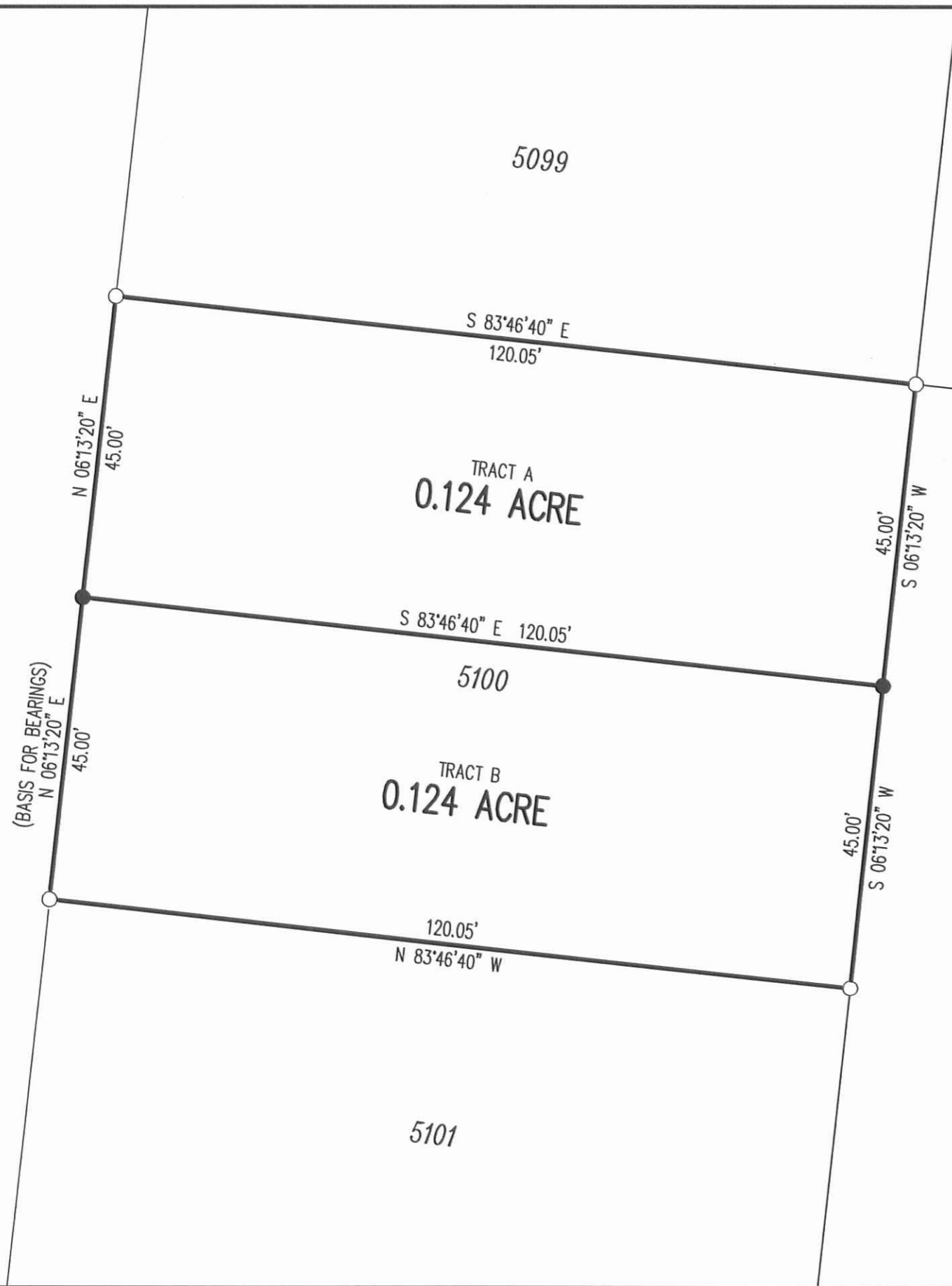

CHARLES W. STANFORD
 5.00 ACRES
 O.R. 490, PG. 429

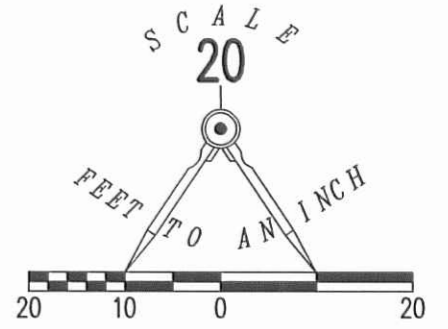

LEGEND:

- 5/8 INCH IRON ROD FOUND
- 5/8 INCH IRON ROD SET WITH PLASTIC I.D. CAP STAMPED "LSM 7437"

SURVEY OF TWO TRACTS OUT OF
 LOT 5100
 BELLE PINES SUBDIVISION
 PHASE II
 PLAT CABINET B, SLIDE 102A
 VIRGINIA MILITARY SURVEY 4478
 CITY OF BELLEFONTAINE
 JEFFERSON TOWNSHIP
 LOGAN COUNTY, OHIO

RONALD E. STANFORD
 2.50 ACRES
 O.R. 325, PG. 701

SURVEYED BY:

William K. Bruce

WILLIAM K. BRUCE
 PROFESSIONAL SURVEYOR 7437
 JUNE 12, 2013



ORIGINAL STAMP IN GREEN

COPYRIGHT 2013 BY:
LEE SURVEYING & MAPPING CO., INC.
 117 North Madriver Street
 BELLEFONTAINE, OHIO 43311
 (937) 593-7335
 WWW.LSMINC.US
 surveys@lsminc.us

2 WORKING DAYS
BEFORE YOU DIG
 CALL TOLL FREE **800-362-2764**
 OHIO UTILITIES PROTECTION SERVICE

KSS D0513 33830513A L-3383-3

INDEXED ON MAP
 8738 6P

3-15-19
 APPROVED

LEGEND:

- ⊗ RAILROAD SPIKE FOUND 4766
- 5/8 INCH IRON ROD FOUND (I.D. CAP STAMPED "PS 7437")
- 5/8 INCH BY 30 INCH IRON ROD FOUND WITH PLASTIC I.D. CAP STAMPED "P.S. 8533"
- R/W = RIGHT-OF-WAY
- C/L = CENTER-LINE

DEED & SURVEY REFERENCES:

O.R. 1309, PG. 593
 BELLE PINES SUBDIVISION PHASE II
 PLAT CABINET B, SLIDES 102A & 102B
 WHISPERING PINES NO. 2
 PLAT CABINET A, SLIDES 697A - 699A

5095

WHISPERING PINES NO. 2

PLAT CABINET A, SLIDES 697A - 699A

4765

(BASIS FOR BEARINGS)
 S 83°46'40" E

200.11'

12' EASEMENT

4764

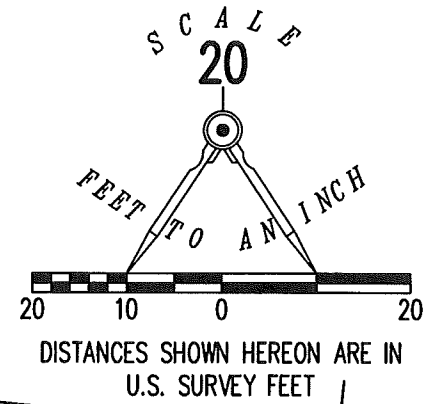

5096
 BRIAN HOGAN AND
 LINDSAY HOGAN
 O.R. 1309, PAGE 593

**RETRACEMENT SURVEY OF THE
 BRIAN HOGAN AND
 LINDSAY HOGAN
 LOT 5096**

**BELLE PINES SUBDIVISION PHASE II
 PLAT CABINET B, SLIDES 102A AND 102B
 OFFICIAL RECORD 1309, PAGE 593
 VIRGINIA MILITARY SURVEY 4478
 CITY OF BELLEFONTAINE
 JEFFERSON TOWNSHIP
 LOGAN COUNTY, OHIO**

5097

CURVE	DELTA ANGLE	RADIUS	ARC LENGTH	CHORD BEARING	CHORD LENGTH
C1	67°45'53"	50.00'	59.14'	N 83°46'48" W	55.75'

BASIS FOR BEARINGS:

THE BASIS FOR BEARINGS, SHOWN HEREON, IS THE NORTH LINE OF BELLE PINES SUBDIVISION PHASE II, BEING S 83°46'40" E.

THIS SURVEY WAS PREPARED IN THE ABSENCE OF A COMPLETE AND ACCURATE TITLE SEARCH AND DOES NOT GUARANTEE TITLE.

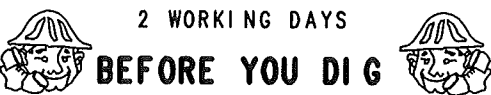

CALL TOLL FREE **800-362-2764**

OHIO UTILITIES PROTECTION SERVICE

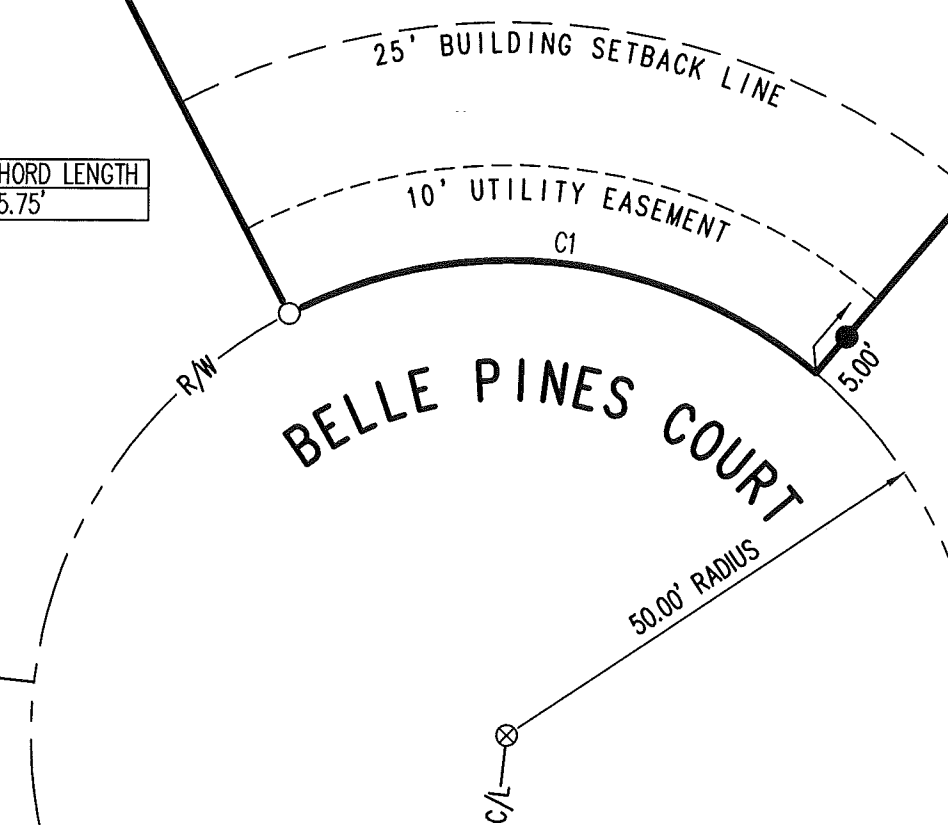

SURVEYED BY:

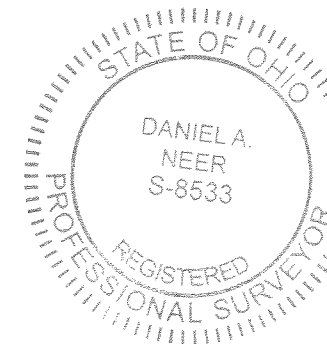

D. Neer
 DANIEL A. NEER
 PROFESSIONAL SURVEYOR NO. 8533
 MARCH 8, 2019

COPYRIGHT 2019 BY:
LEE SURVEYING & MAPPING CO.
 117 North Madriver Street
 BELLEFONTAINE, OHIO 43311
 (937) 593-7335
 WWW.LEE-SURVEYING.COM
 surveys@lee-surveying.com
 KSS D0219 33830219 L-3383-3

INDEXED ON MAP
 8738

12-4-19

 **APPROVED**

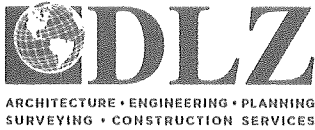

INNOVATIVE IDEAS
EXCEPTIONAL DESIGN
UNMATCHED CLIENT SERVICE

SCHMIDT
0.148 ACRE

Lying in Virginia Military Survey 4478, City of Bellefontaine, Jefferson Township, Logan County, Ohio (all records referenced herein refer to the Logan County Records of Deeds).

Being out of the Shawn E. Schmidt and Eleanor S. Schmidt Lot 4927 of Belle Pines Subdivision (Plat Cabinet A, Slides 93A & 93B) as deeded and described in Official Record 1219, Page 74 and being more particularly described as follows:

BEGINNING at a 5/8 inch iron rod found at the northeast corner of said Lot 4927 and the Bellefontaine Corporation Line, the northwest corner of the Shawn E. Schmidt and Eleanor S. Schmidt 1.022 acre tract as deeded and described in Official Record 1013, Page 825 and being on the south line of the Ronald E. Stanford 2.50 acre tract as deeded and described in Official Record 325, Page 701;

THENCE, with common lines to said Lot 4927, Bellefontaine Corporation Line and 1.022 acre tract, **S 05°-17'-56" W**, a distance of **149.98 feet** to a 5/8 inch iron rod found on the north right-of-way line of White Pines Drive (60 feet wide);

THENCE, with the common line to said Lot 4927 and north right-of-way line, **N 85°-12'-29" W**, a distance of **43.02 feet** to an iron rebar set;

THENCE, with a new division line through said Lot 4927, **N 05°-21'-59" E**, a distance of **150.37 feet** to an iron rebar set on the common line to said Lot 4927, Bellefontaine Corporation Line and 2.50 acre tract;

INDEXED ON MAP
8730



INNOVATIVE IDEAS
EXCEPTIONAL DESIGN
UNMATCHED CLIENT SERVICE

THENCE, with said common line, **S 84°-41'-09" E**, a distance of **42.84 feet** to the **POINT OF BEGINNING**.

Containing **0.148 acre**, more or less.

Iron rebar set, where indicated, are 30 inches in length, 5/8 inch in diameter with a plastic I.D. cap stamped "DLZ OHIO INC."

Property is subject to any and all previous easements and rights-of-way of record.

Bearings and distances, described herein, are derived from GPS observations based on Grid North, Ohio State Plane Coordinate System, North Zone, NAD83 (2011, Epoch 2010), with the north right-of-way line of White Pines Drive having a bearing of N 85°-12'-29" W. Distances are expressed in U.S. Survey Feet. All other measurements are from angles and distances measured in a field survey by DLZ on December 2, 2019.

Description prepared by:

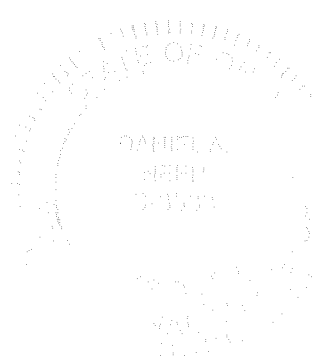

[Handwritten Signature]
Daniel A. Neer

Professional Surveyor No. 8533

December 2, 2019

1921-2101.00

INDEXED ON MAP
8738

12-4-19



APPROVED

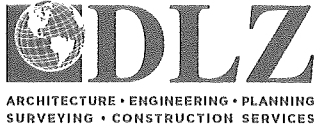

INNOVATIVE IDEAS
EXCEPTIONAL DESIGN
UNMATCHED CLIENT SERVICE

SCHMIDT 0.147 ACRE

Lying in Virginia Military Survey 4478, City of Bellefontaine, Jefferson Township, Logan County, Ohio (all records referenced herein refer to the Logan County Records of Deeds).

Being out of the Shawn E. Schmidt and Eleanor S. Schmidt Lot 4927 of Belle Pines Subdivision (Plat Cabinet A, Slides 93A & 93B) as deeded and described in Official Record 1219, Page 74 and being more particularly described as follows:

COMMENCING at a 5/8 inch iron rod found at the northeast corner of said Lot 4927 and the Bellefontaine Corporation Line, the northwest corner of the Shawn E. Schmidt and Eleanor S. Schmidt 1.022 acre tract as deeded and described in Official Record 1013, Page 825 and being on the south line of the Ronald E. Stanford 2.50 acre tract as deeded and described in Official Record 325, Page 701;

THENCE, with the common line to said Lot 4927, Bellefontaine Corporation Line and 2.50 acre tract, N 84°-41'-09" W, a distance of 42.84 feet to an iron rebar set at the **TRUE POINT OF BEGINNING**;

THENCE, with a new division line through said Lot 4927, **S 05°-21'-59" W**, a distance of **150.37 feet** to an iron rebar set on the north right-of-way line of White Pines Drive (60 feet wide);

THENCE, with the common line to said Lot 4927 and north right-of-way line, **N 85°-12'-29" W**, a distance of **42.55 feet** to an iron rebar set at the southwest corner of said Lot 4927 and the southeast corner of Lot 4926 of said Subdivision;

INDEXED ON MAP
8738

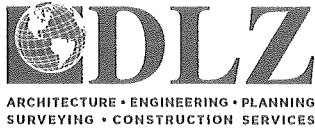

INNOVATIVE IDEAS
EXCEPTIONAL DESIGN
UNMATCHED CLIENT SERVICE

THENCE, with the common line to said Lots 4927 and 4926, **N 05°-26'-01" E**, a distance of **150.76 feet** to an iron rebar set at the common corner to said Lots 4927 and 4926 and being on the common line to said Bellefontaine Corporation Line and 2.50 acre tract;

THENCE, with said common line, **S 84°-41'-09" E**, a distance of **42.38 feet** to the **POINT OF BEGINNING**.

Containing **0.147 acre**, more or less.

Iron rebar set, where indicated, are 30 inches in length, 5/8 inch in diameter with a plastic I.D. cap stamped "DLZ OHIO INC."

Property is subject to any and all previous easements and rights-of-way of record.

Bearings and distances, described herein, are derived from GPS observations based on Grid North, Ohio State Plane Coordinate System, North Zone, NAD83 (2011, Epoch 2010), with the north right-of-way line of White Pines Drive having a bearing of N 85°-12'-29" W. Distances are expressed in U.S. Survey Feet. All other measurements are from angles and distances measured in a field survey by DLZ on December 2, 2019.

Description prepared by:

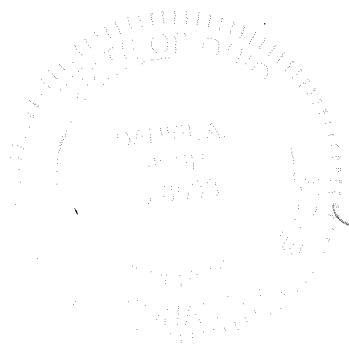

D. A. Neer
Daniel A. Neer

Professional Surveyor No. 8533

December 2, 2019

1921-2101.00

INDEXED ON MAP
0738

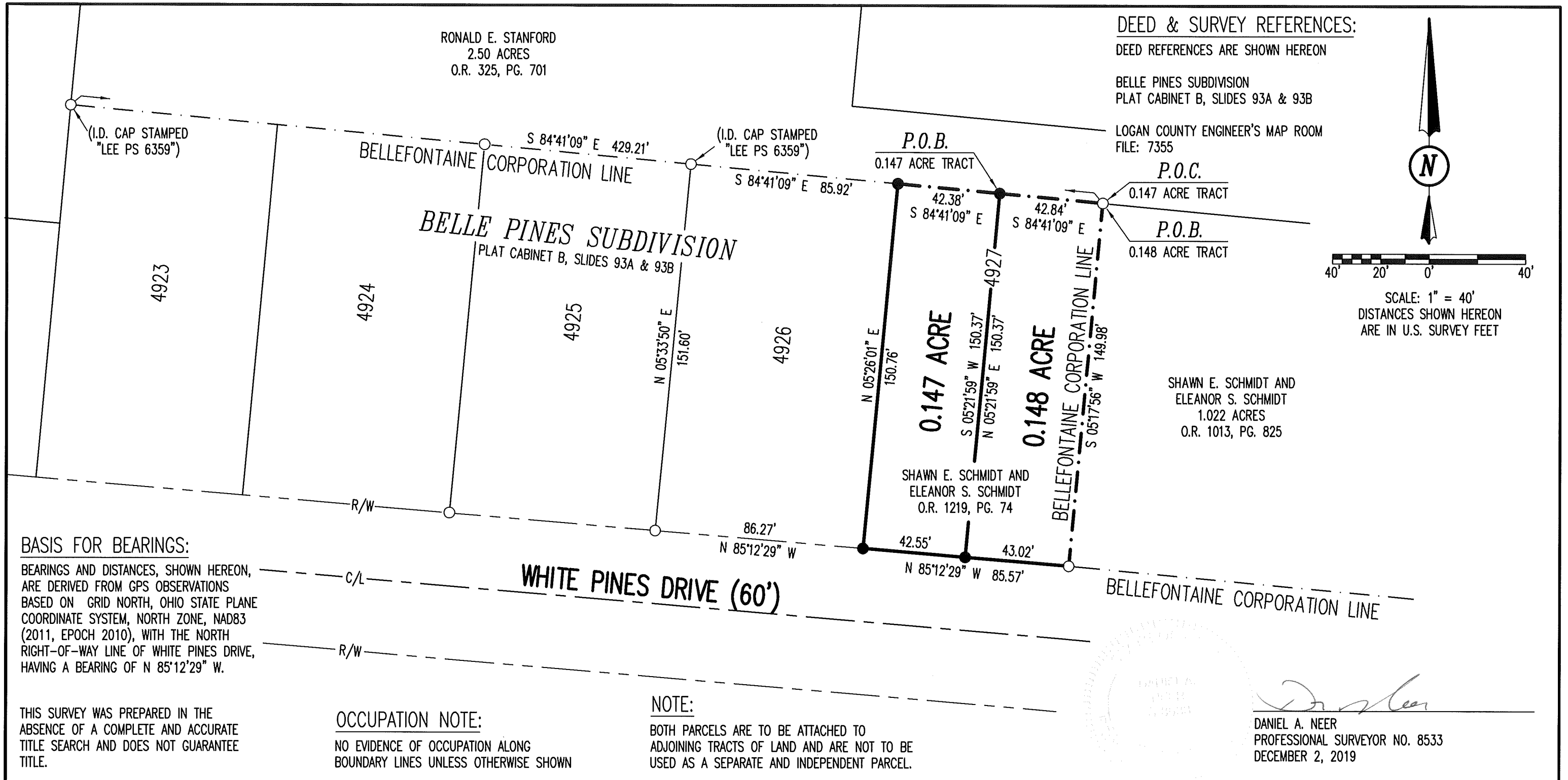

COPYRIGHT 2019 BY:
DLZ
 117 N. Madriver Street • Bellefontaine, OH 43311
 (937) 593-7335 • www.dlz.com
 Project #1921-2101.00

LEGEND	
○ 5/8 INCH IRON ROD FOUND	P.O.C. = POINT OF COMMENCEMENT
● 5/8 INCH BY 30 INCH IRON REBAR SET WITH I.D. CAP STAMPED "DLZ OHIO INC."	P.O.B. = POINT OF BEGINNING
	R/W = RIGHT-OF-WAY
	C/L = CENTER-LINE

SURVEY OF TWO TRACTS
 OUT OF THE
 SHAWN E. SCHMIDT AND ELEANOR S. SCHMIDT
 LOT 4927 OF BELLE PINES SUBDIVISION
 OFFICIAL RECORD 1219, PAGE 74
 VIRGINIA MILITARY SURVEY 4478
 CITY OF BELLEFONTAINE
 JEFFERSON TOWNSHIP, LOGAN COUNTY, OHIO

DRAWN BY:	DESCRIPTION	REV. NO.	DATE
KSS			12/2/2019

INDEXED ON MAP
 8730

PINEBROOKE PLANNED UNIT DEVELOPMENT

VIRGINIA MILITARY SURVEYS 3220 AND 5738, CITY OF BELLEFONTAINE,
JEFFERSON TOWNSHIP, LOGAN COUNTY, OHIO

MARCH, 2021

DEDICATION AND ACKNOWLEDGEMENT:

The undersigned, RPM Engineering LLC, an Ohio limited liability company (the "Declarant"), owner of the Property platted herein, hereby certifies that this Plat correctly represents the Property which comprises PINEBROOKE P.U.D. in Bellefontaine, Ohio (the "Planned Unit Development"), and Declarant does hereby authorize and accept this Plat and dedicate to private use the Private Road designated as Blazing Trail and Common Areas shown herein and not heretofore dedicated. The Property and each Lot transferred therefrom, and Private Road and Common Areas, shall be subject to the terms, provisions, covenants, conditions and restrictions set forth in the Declaration of Covenants, Conditions, Restrictions, Road Right-of-Ways, Easements, Assessments and Assessment Liens applicable to the P.U.D. (the "Declaration"). The dedication to public use of all streets and portions of streets designated as Township Road 179 and U.S. Route 33 as shown upon this Map; said dedication are for any and all public uses upon said streets and portions thereof. The Declaration is hereby incorporated herein by reference. The capitalized terms set forth in this Declaration and as used on this Plat are defined terms in the Declaration shall have the same meanings in this Declaration as set forth in the Declaration.

The Private Road and Common Areas are dedicated for the private and exclusive use and access of the Declarant, Owner, Occupants, police, firemen, emergency personnel and others as specified in the Declaration. No public agency, state, county, township or municipality is responsible for maintenance, repair, reconstruction, etc. of the Private Road and Common Areas and the responsibility rests with the PINEBROOKE P.U.D. Homeowners Association Inc., an Ohio nonprofit corporation, as specified in the Declaration.

Any use of the Lots and Improvements shall be in conformity with all existing valid zoning, platting, health or other lawful rules and regulations of Logan County, Ohio, the City of Bellefontaine and/or Jefferson Township, for the benefit of the Declarant and the future Owners, and their respective heirs, successors and assigns, taking title through the Declarant. Building minimum setback distances for the Lots will be set at twenty five (25) feet from outside boundary of Road right-of-way on this Plat.

The following Road Right-of-Ways (Reserve A) and Easements are reserved and dedicated with respect to the Property and the P.U.D.:

- (a) All road right-of-ways and easements shown on this Plat;
- (b) A sixty (60) foot Road Right-of-Way identified as (Reserve A) includes the private street and flanking utilities within the sixty (60) foot designation.
- (c) A five (5) foot easement running along each side of sanitary system lines that are not included within the sixty (60) foot right-of-way (Reserve A) designation.

The foregoing road right-of-ways and easements are reserved and dedicated for the following purposes:

- (i) Public and Private Utility uses above and beneath the surface of the ground;
- (ii) The construction, operation, maintenance, repair, replacement or removal of water, sewer, gas, electric, telephone, cable, fiber optics, or other utility lines or services.
- (iii) The removal of any and all trees, vegetation or other obstructions to the use of said utilities; and
- (iv) The construction, operation, maintenance, repair, replacement, or removal of Improvements above and beneath the surface of the ground which are part of the drainage system used for the detention and transport of surface and storm waters for the P.U.D., or which are necessary to support and operate such drainage system, including without limitation, subsurface tile and drain outlets.
- (v) The "Open Spaces" Recreational Common area easement dedicated on this Plat is to be used for PINEBROOKE ("P.U.D.") residents for recreation or social purposes and is readily accessible by all PINEBROOKE ("P.U.D.") residents.

It shall be lawful for any such utility, public or private, or its employees, agents or contractors, to enter upon the Private Road and said road right-of-ways and easements at any time for the purpose of carrying out the objectives for which said right-of-ways and easements are reserved and dedicated. Except for items necessary for the purpose of carrying out the objectives for which said road right-of-ways are reserved and dedicated, the "Declarant" may determine where permanent structures and plantings are to be permitted within the right-of-ways running along each side of the Private Road.

In addition to the foregoing road right-of-ways and easements, an exclusive two (2) feet diameter easement is reserved and dedicated at all Property corners and points of curvature for monumentation. No surface of buried utilities of any kind may be placed within these easement areas.

Ownership of any Improvements and Common Areas and Common Facilities, including the Private Road, is set forth in the Declaration. This plat consists of three (3) pages and all pages must be used for complete representation of the P.U.D.

OWNER AND DECLARANT:
RPM Engineering LLC, an Ohio limited liability company

By: Richard Moldas
Richard Moldas, Member

STATE OF OHIO, COUNTY OF LOGAN, SS:

This instrument was acknowledged before me on this 14th day of July, 2021, by Richard Moldas as Member of RPM Engineering LLC, an Ohio limited liability company, on behalf of said company.

Kae O'Lea
Notary Public

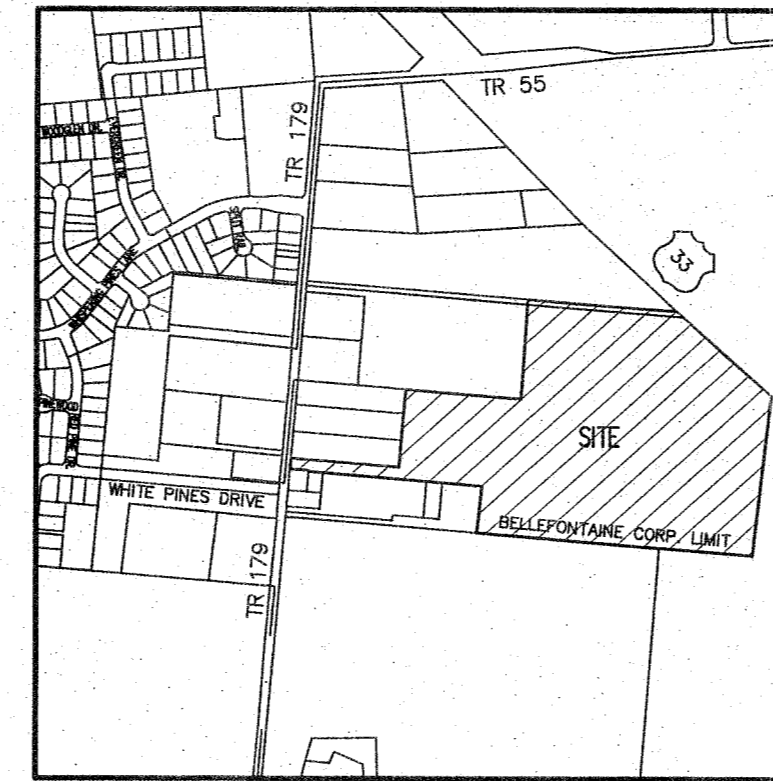
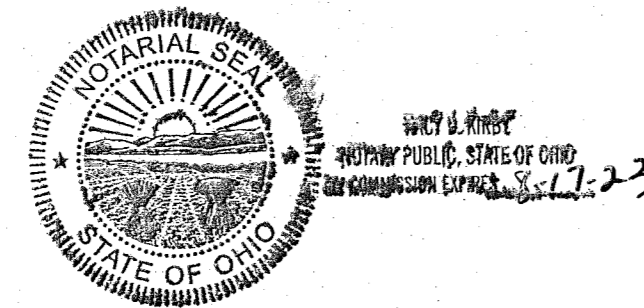

LOCATION MAP
NOT TO SCALE

OWNER AND DECLARANT:
RPM ENGINEERING LLC.

BY: Richard Moldas

PRINT NAME: Richard Moldas

TITLE: Owner & Declarant

STATE OF OHIO, COUNTY OF LOGAN ss:

Before me, a Notary Public, in and for said County, on this 14th day of July, 2021, personally came Richard Moldas, who acknowledge the signing of the foregoing instrument to be their voluntary act and deed for the uses and purposes therein expressed.

IN WITNESS WHEREOF, I have hereunto set my hand and affixed my official seal this 14th day of July, 2021.

Kae O'Lea
Notary Public
My Commission Expires: 8-1-23

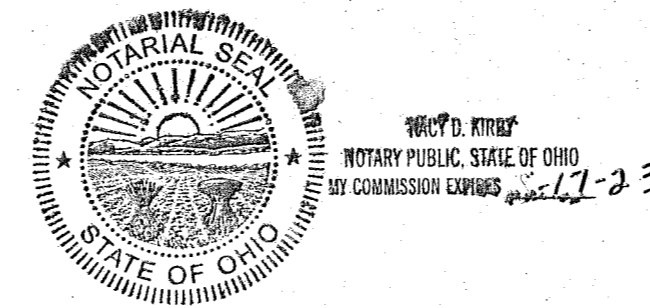

SURVEYOR'S CERTIFICATE

The accompanying plat represents a planned unit development in Virginia Military Surveys 3220 and 5738, City of Bellefontaine, Jefferson Township, Logan County, Ohio. The tract has an area of 2.695 acres in Private Streets, 45.991 acres in lots and 1.812 acres within the public road rights-of-way of Township Road 179 and U.S. Route 33, making a total of 50.498 acres.

All measurements are in U.S. feet and decimals of a foot.

I hereby certify that the accompanying plat is a correct representation of "Pinebrooke Planned Unit Development" as surveyed March, 2021 and that all monuments have been set or will be set upon completion of construction as directed by the declarant.

DLZ Ohio, Inc.

BY: Robert J. Sands 07/10/21
Robert J. Sands
Professional Surveyor No. S-8053

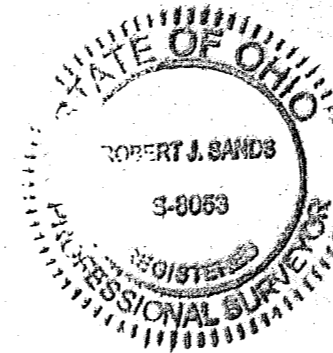

The within public easements are hereby approved and accepted for public maintenance by Ordinance No. 21-32 recorded in City Council's Record Book 2021 on this day of June 22nd, 20 21.

APPROVED THIS 7th DAY OF July, 20 21.

Ben Stahler
Mayor of Bellefontaine

APPROVED THIS 7th DAY OF July, 20 21.

By City
President, Bellefontaine City Council

APPROVED THIS 13th DAY OF July, 20 21.

Bonnie Campbell
Clerk, Bellefontaine City Council

APPROVED THIS 7th DAY OF July, 20 21.

F. J. ..., P.E., P.S.
Bellefontaine City Engineer

APPROVED THIS 7th DAY OF July, 20 21.

[Signature]
Chairman, Bellefontaine City Planning Commission

Plat Pre-approved Angela M. Cochran 7-7-2021

Plat Checked [Signature] 7-14-21

Transferred this day of July 14, 20 21.

[Signature]
Logan County Auditor

Filed for record this day of July 14, 20 21, at 11:35 A.M.
Recorded this day of July 14, 20 21, in Plat Cabinet B,
Slides 153A, 153B and 154A.

Patricia A. Myer
Logan County Recorder

DESCRIPTION

Lying in Virginia Military Surveys 3220 and 5738, City of Bellefontaine, Jefferson Township, Logan County, Ohio (all records referenced herein refer to the Logan County Records of Deeds).

Being all of the RPM Engineering LLC, 50.494 acre tract as deeded and described in Official Record 1396, Page 642 and being more particularly described as follows:

COMMENCING at a railroad spike found at the intersection of the center-lines of White Pines Drive (60 feet wide) and Township Road 179 (60 feet wide);

THENCE, with said center-line of Township Road 179, N 05°-23'-36" E, a distance of 108.75 feet to a MAG nail set at the TRUE POINT OF BEGINNING, being the westerly corner common to said 50.494 acre tract and the Glenn E. Hill and Angela D. Hill 0.371 acre tract as deeded and described in Official Record 581, Page 177;

THENCE, continuing with said center-line, N 05°-23'-36" E, a distance of 59.94 feet to a railroad spike found at the westerly corner common to said 50.494 acre tract and the Steven A. Akers 2.169 acre tract as deeded and described in Official Record 1027, Page 339, Tract II;

THENCE, with a line common to said 50.494 acre and 2.169 acre tracts, S 85°-25'-14" E, a distance of 628.96 feet to a concrete monument set, passing a concrete monument set at a distance of 29.86 feet;

THENCE, with a westerly line of said 50.494 acre tract and the easterly line of said 2.169 acre tract and the Steven A. Akers 2.169 acre and 1.943 acre tracts as deeded and described in Official Record 1027, Page 339, Tract I and II, respectively, N 05°-09'-51" E, passing 5/8 inch iron rebar found at distances of 299.37 feet and 423.38 feet, a total distance of 433.02 feet to a concrete monument set on the southerly line of the Robert A. Powell and Gretchen J. Powell 14.39 acre tract as deeded and described in Official Record 692, Page 628 and on a northerly Bellefontaine Corporation Line;

THENCE, with lines common to said 50.494 acre and 14.39 acre tracts and the Bellefontaine Corporation Line, the following two (2) courses:

- S 85°-28'-57" E, passing a 5/8 inch iron rebar found at a distance of 249.56 feet, a total distance of 669.71 feet to a 5/8 inch iron rebar found; and
- N 05°-01'-44" E, a distance of 549.90 feet to a 3/4 inch iron pipe found on the southerly line of the Robert D. Walker 19.466 acre tract as deeded and described in Official Record 864, Page 648, Parcel I;

THENCE, with a line common to said 50.494 acre and 19.466 acre tracts and the Bellefontaine Corporation line, S 85°-23'-14" E, passing a 3/4 inch iron rebar found at a distance of 834.14, a concrete monument set on the southwesterly limited access right-of-way line of U.S. Route 33 (width varies) 837.62 feet, a total distance of 1116.70 feet to a point on the center-line of said U.S. Route 33;

THENCE, with said center-line, the following two courses:

- With a curve to the left, having a delta angle of 0°-07'-43", a radius of 12277.67 feet, an arc length of 27.53 feet, a chord bearing S 50°-34'-11" E, a distance of 27.53 feet to a point; and
- S 51°-01'-58" E, a distance of 287.17 feet to a point at a corner common to said 50.494 acre tract and the David A. Crissman and Marcia E. Crissman 55.08 acre tract as deeded and described in Official Record 1394, Page 870;

THENCE, with a line common to said 50.494 acre and 55.08 acre tracts and said Corporation Line, S 06°-12'-20" W, passing a 6 inch concrete monument set at a distance of 190.27 feet on the southerly right-of-way line of said U.S. Route 33, a 5/8 inch iron rebar found at a distance of 191.86 feet, a total distance of 1137.15 feet to a 5/8 inch iron rebar found on the westerly line of said 50.08 acre tract and a corner common to said 50.494 acre tract and Corporation Line and the Gary L. Alexander, Jr., 41.22 acre tract as deeded and described in Official Record 1245, Page 569, Tract II;

THENCE, with a southerly line of said 50.494 acre tract and said Corporation Line and the northerly lines of said 41.22 acre tract and the Gary L. Alexander, Jr., 36.373 acre tract as deeded and described in Official Record 1187, Page 342 and 10.538 acre tract as deeded and described in Official Record 1260, Page 333, N 85°-22'-09" W, a distance of 1538.92 feet to a 5/8 inch iron rebar found, corner common to said 50.494 acre tract and Corporation Line and the Matthew D. Watkins and Rebecca L. Watkins 2.571 acre tract as deeded and described in Official Record 301, Page 204 and on the north line of said 10.538 acre tract;

THENCE, with a common line to said 50.494 acre and 2.571 acre tracts and Corporation Line, N 05°-04'-10" E, a distance of 264.15 feet to a 5/8 inch iron rebar found;

THENCE, with the southerly lines of said 50.494 acre tract and Corporation Line and the northerly lines of said 2.571 acre tract and the Terry D. Maynard 3.192 acre tract as deeded and described in Official Record 440, Page 916, N 85°-24'-51" W, a distance of 902.34 feet to a concrete monument set on the westerly line of the Glenn E. Hill and Angela D. Hill, 0.220 acre tract as deeded and described in Official Record 1011, Page 607;

THENCE, with a line common to said 50.494 acre and 0.220 acre tracts, N 04°-59'-27" E, a distance of 6.06 feet to a concrete monument set at the corner common to said 50.494 acre and 0.220 acre tracts;

THENCE, with a line common to said 50.494 acre and 0.220 acre tracts, N 85°-23'-55" W, a distance of 80.11 feet to a concrete monument set at a corner common to said 50.494 acre, 0.220 acre and 0.371 acres tracts;

THENCE, with a line common to said 50.494 acre and 0.371 acre tracts, N 85°-25'-01" W, passing a 5/8 inch iron rebar found at a distance of 104.14 feet, a total distance of 134.06 feet to the POINT OF BEGINNING.

Containing 50.498 acres, more or less, of which 1.812 acres are within the public road right-of-way of Township Road 179 and U.S. Route 33.

Iron rebar set, where indicated, are 30 inches in length, 3/4 inch in diameter with a plastic I.D. cap stamped DLZ OHIO INC.®

Concrete monument set, where indicated, are 36 inches in length and 6 inches in diameter with a 3/4 inch by 30 inch iron rebar set with a plastic I.D. cap stamped "DLZ OHIO INC.®"

Property is subject to any and all previous easements and rights-of-way of record.

Bearings and distances, described herein, are derived from GPS observations based on Grid North, Ohio State Plane Coordinate System, North Zone, NAD83 (2011, Epoch 2010), with the center-line of Township Road 179, having a bearing of N 05°-23'-36" E. Distances are expressed in U.S. Survey Feet. All other measurements are from angles and distances measured in a field survey by DLZ Ohio, Inc. in March, 2021.

Description prepared by Robert J. Sands, Professional Surveyor No. 8053.

PINEBROOKE PLANNED UNIT DEVELOPMENT

VIRGINIA MILITARY SURVEYS 3220 AND 5738, CITY OF BELLEFONTAINE, JEFFERSON TOWNSHIP, LOGAN COUNTY, OHIO

2
3

SCALE: 1" = 100'
DISTANCES SHOWN HEREON ARE IN U.S. SURVEY FEET

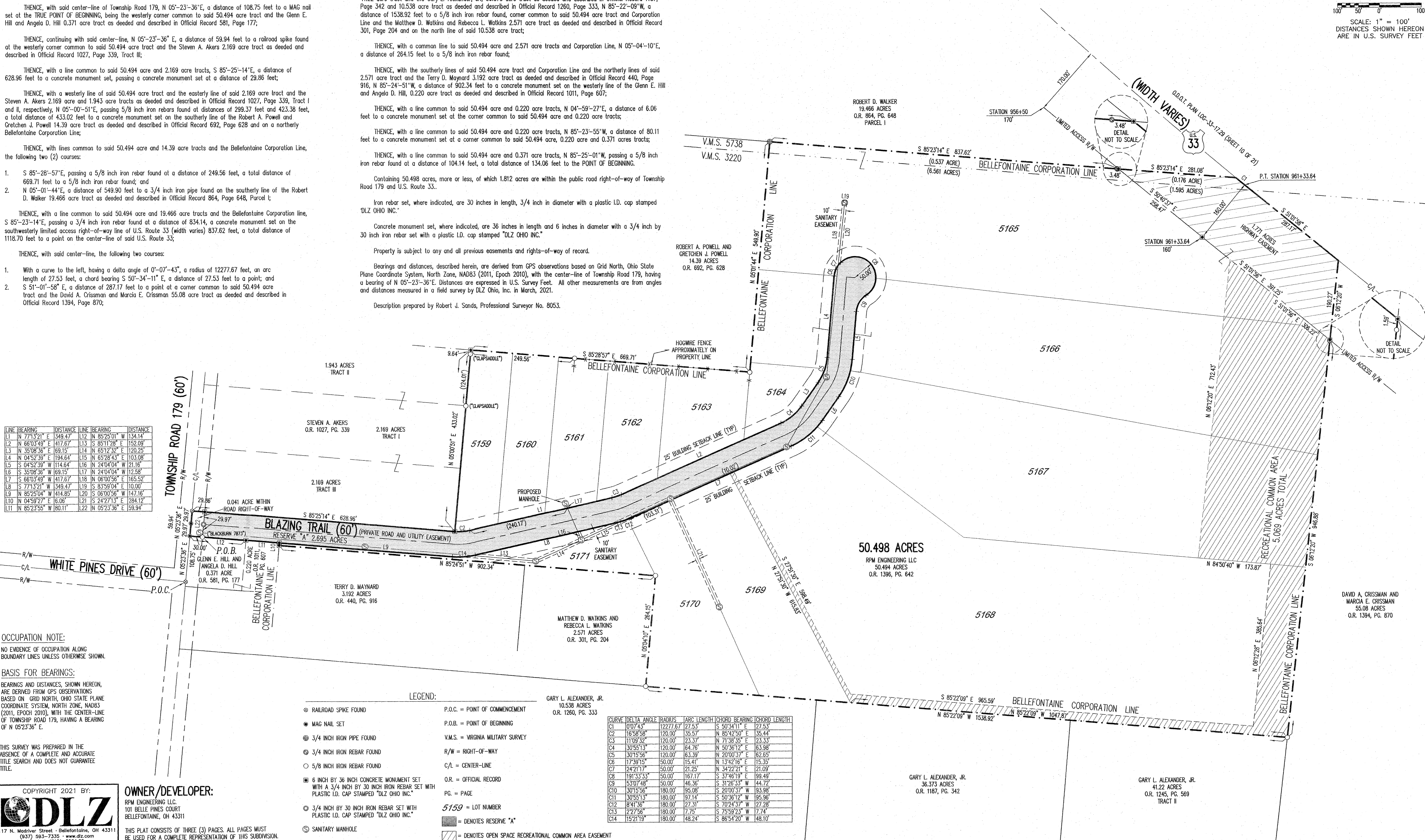

COPYRIGHT 2021 BY:
DLZ
117 N. Madriver Street • Bellefontaine, OH 43311
(937) 563-7335 • www.dlz.com
Project #2121-2004.00

OWNER/DEVELOPER:
RPM ENGINEERING LLC
101 BELLE PINES COURT
BELLEFONTAINE, OH 43311
THIS PLAT CONSISTS OF THREE (3) PAGES. ALL PAGES MUST BE USED FOR A COMPLETE REPRESENTATION OF THIS SUBDIVISION.

DAVID A. CRISSMAN AND MARGA E. CRISSMAN
55.08 ACRES
O.R. 1394, PG. 870

- LEGEND:**
- ⊙ RAILROAD SPIKE FOUND
 - MAG NAIL SET
 - ⊙ 3/4 INCH IRON PIPE FOUND
 - ⊙ 3/4 INCH IRON REBAR FOUND
 - ⊙ 5/8 INCH IRON REBAR FOUND
 - ⊙ 6 INCH BY 36 INCH CONCRETE MONUMENT SET WITH A 3/4 INCH BY 30 INCH IRON REBAR SET WITH PLASTIC I.D. CAP STAMPED "DLZ OHIO INC."
 - ⊙ 3/4 INCH BY 30 INCH IRON REBAR SET WITH PLASTIC I.D. CAP STAMPED "DLZ OHIO INC."
 - ⊙ SANITARY MANHOLE
- P.O.C. = POINT OF COMMENCEMENT
P.O.B. = POINT OF BEGINNING
V.M.S. = VIRGINIA MILITARY SURVEY
R/W = RIGHT-OF-WAY
C/L = CENTER-LINE
O.R. = OFFICIAL RECORD
PG. = PAGE
5159 = LOT NUMBER

DEED & SURVEY REFERENCES:
DEED REFERENCES SHOWN HEREON
O.D.O.T. PLANS LOC-33-17.29
LOGAN COUNTY ENGINEER'S MAP ROOM FILES:
L-40, 6963, 6964, 7075, 7163 AND 7405

PINEBROOKE PLANNED UNIT DEVELOPMENT

VIRGINIA MILITARY SURVEYS 3220 AND 5738, CITY OF BELLEFONTAINE,
JEFFERSON TOWNSHIP, LOGAN COUNTY, OHIO

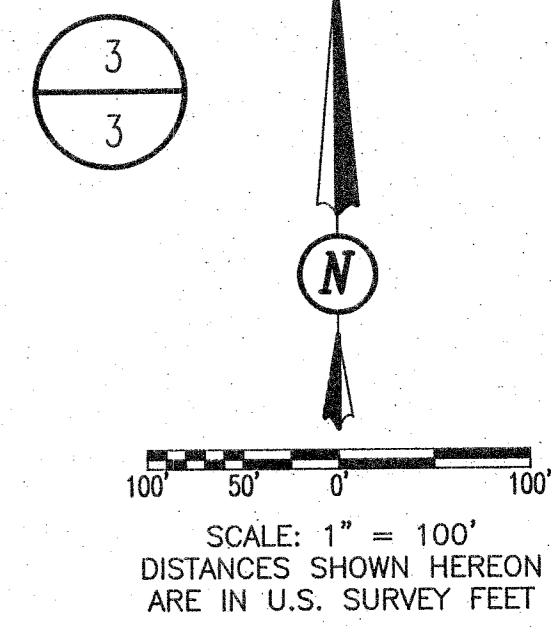

LINE	BEARING	DISTANCE
L1	S 85°25'04" E	628.70'
L2	N 77°13'21" E	349.47'
L3	N 66°03'49" E	417.67'
L4	N 35°08'36" E	69.15'
L5	N 04°52'39" E	194.64'
L6	S 85°07'21" E	203.00'
L7	N 77°13'21" E	349.47'
L8	N 66°03'49" E	103.31'
L9	N 66°03'49" E	154.49'
L10	N 66°03'49" E	159.88'
L11	N 35°08'36" E	69.15'
L12	N 04°52'39" E	114.64'
L13	S 04°52'39" W	194.64'
L14	S 35°08'36" W	69.15'
L15	S 66°03'49" W	97.13'
L16	S 66°03'49" W	276.42'
L17	S 66°03'49" W	94.13'
L18	N 77°13'21" E	377.33'
L19	N 77°13'21" E	126.92'
L20	N 77°13'21" E	115.20'
L21	S 77°13'21" W	69.62'
L22	N 04°59'27" E	6.06'
L23	N 85°23'55" W	80.11'
L24	N 85°25'01" W	134.06'
L25	S 85°25'04" E	414.85'
L26	N 05°23'36" E	59.94'

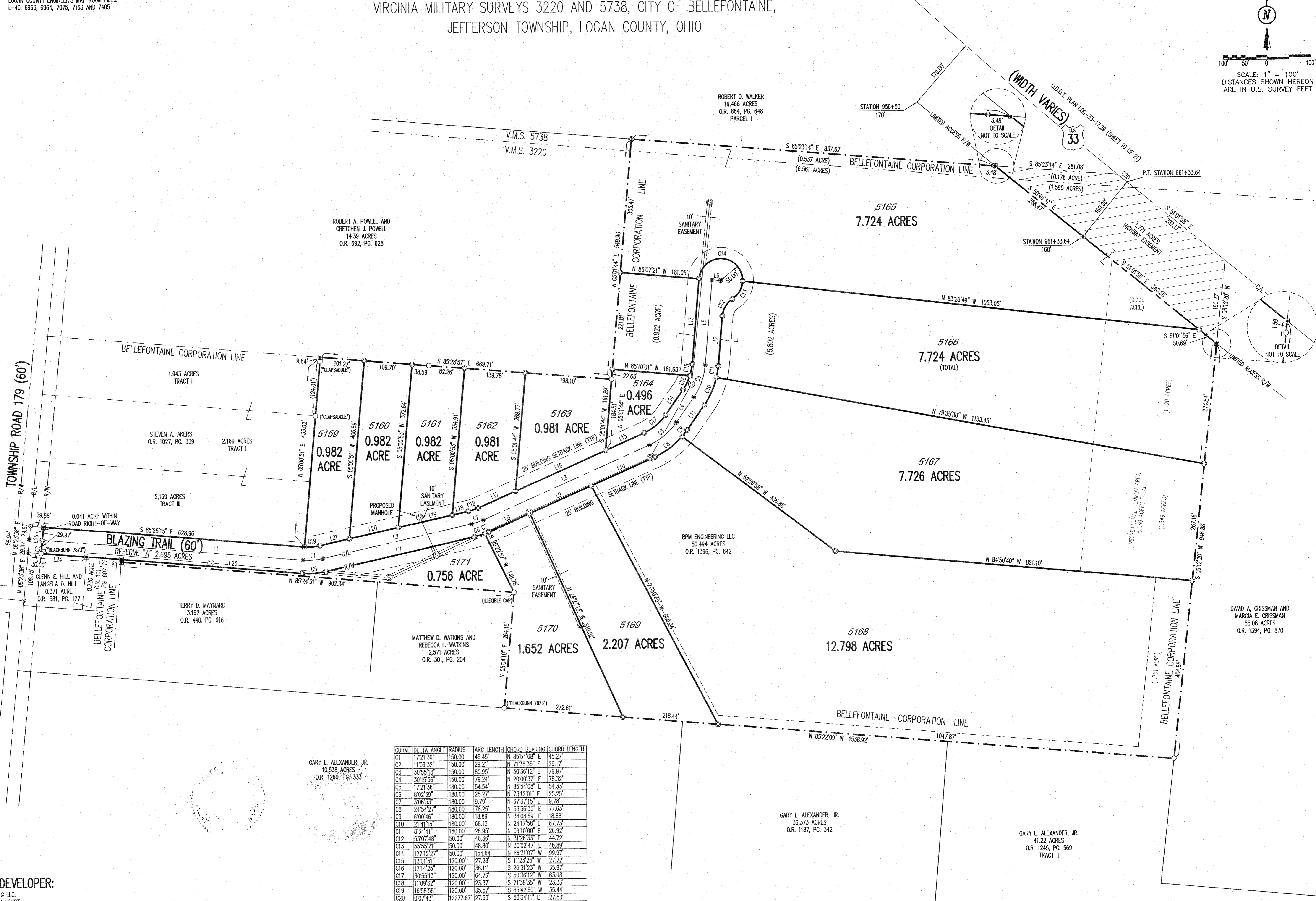

OCCUPATION NOTE:
NO EVIDENCE OF OCCUPATION ALONG BOUNDARY LINES UNLESS OTHERWISE SHOWN.

BASIS FOR BEARINGS:
BEARINGS AND DISTANCES SHOWN HEREON ARE DERIVED FROM GPS OBSERVATIONS BASED ON GRID NORTH, OHIO STATE PLANE COORDINATE SYSTEM, NORTH ZONE, NAD83 (2011, EPOCH 2010), WITH THE CENTER-LINE OF TOWNSHIP ROAD 179, HAVING A BEARING OF N 05°23'36" E.

THIS SURVEY WAS PREPARED IN THE ABSENCE OF A COMPLETE AND ACCURATE TITLE SEARCH AND DOES NOT GUARANTEE TITLE.

GARY L. ALEXANDER, JR.
10,538 ACRES
O.R. 1260, PG. 333

CURVE	DELTA ANGLE	RADIUS	ARC LENGTH	CHORD BEARING	CHORD LENGTH
C1	172°1'36"	150.00'	45.45'	N 85°54'08" E	45.27'
C2	110°9'32"	150.00'	29.21'	N 71°38'35" E	29.17'
C3	30°55'13"	150.00'	80.95'	N 50°36'12" E	79.97'
C4	30°15'56"	150.00'	79.24'	N 20°00'37" E	78.32'
C5	172°1'36"	180.00'	54.54'	N 85°54'08" E	54.33'
C6	80°2'39"	180.00'	25.27'	N 73°12'01" E	25.25'
C7	3°06'53"	180.00'	9.79'	N 67°37'15" E	9.78'
C8	24°54'27"	180.00'	78.25'	N 53°36'35" E	77.63'
C9	6°00'46"	180.00'	18.89'	N 38°08'59" E	18.88'
C10	21°41'15"	180.00'	68.13'	N 24°17'58" E	67.73'
C11	8°34'41"	180.00'	28.95'	N 89°10'00" E	28.92'
C12	53°07'48"	50.00'	48.36'	N 31°26'33" E	44.72'
C13	55°55'21"	50.00'	48.80'	N 30°02'47" E	46.89'
C14	177°12'22"	50.00'	154.64'	N 86°31'07" W	99.97'
C15	13°01'31"	120.00'	27.28'	S 11°23'25" W	27.22'
C16	17°14'25"	120.00'	36.11'	S 26°31'23" W	35.97'
C17	30°55'13"	120.00'	64.76'	S 50°36'12" W	63.98'
C18	11°09'32"	120.00'	23.37'	S 71°38'35" W	23.33'
C19	16°58'58"	120.00'	35.57'	S 85°42'50" W	35.44'
C20	0°07'43"	12277.67'	27.53'	S 50°34'11" E	27.53'

GARY L. ALEXANDER, JR.
36.373 ACRES
O.R. 1187, PG. 342

GARY L. ALEXANDER, JR.
41.22 ACRES
O.R. 1245, PG. 569
TRACT II

COPYRIGHT 2021 BY:

117 N. Madriver Street • Bellefontaine, OH 43311
(937) 593-7335 • www.dlz.com
Project #2121-2004.00

OWNER/DEVELOPER:
RPM ENGINEERING LLC
101 BELLE PINES COURT
BELLEFONTAINE, OH 43311

THIS PLAT CONSISTS OF THREE (3) PAGES. ALL PAGES MUST BE USED FOR A COMPLETE REPRESENTATION OF THIS SUBDIVISION.



9-30-21
APPROVED

Richard Moldas
Page 2 of 5
September 10, 2021

Parcel "B"
LEGAL DESCRIPTION

Being a part of a 0.793 acre tract in the name of RPM Engineering, LLC (O.R. 1393, Pg. 4139, Tract III) and being a part of V.M.S. 4478, City of Bellefontaine, Jefferson Township, Logan County, more particularly described as follows:

Beginning at an existing #5 Rebar at the NE corner of Lot #5097 of Belle Pines Subdivision, Phase II (P.C. B, Slide 102A) and the SE corner of Lot #4764 of Whispering Pines No. 2 (P.C. A, Slide 697A); thence the following courses:

1. N 04°-46'-39" E with the E line of said Lot #4764 and the W line of said 0.793 acre tract, 30.00' to #5 Rebar set at the NW corner of said 0.793 acre tract and the SW corner of a 5.000 acre tract in the name of David A. & Jacqueline R. Thompson (O.R. 533, Pg. 279);
2. S 84°-39'-09" E with the N line of said 0.793 acre tract and the S line of said 5.000 acre tract, 325.99' to a set #5 Rebar;
3. S 05°-02'-44" W, 60.00' to a #5 Rebar set on the S line of said 0.793 acre tract and the N line of a 5.000 acre tract in the name of Charles W. & Carol L. Stanford (O.R. 490, Pg. 429);
4. N 84°-39'-09" W with the S line of said 0.793 acre tract and the N line of said 5.000 acre tract, 325.99' to a #5 Rebar set on the E line of said Lot #5097;
5. N 05°-18'-41" E with the W line of said 0.793 acre tract and the E line of said Lot #5097, 30.00' to the POINT OF BEGINNING.

The above described parcel contains 0.449 acres, more or less, subject to all legal highways and easements of record.

The system of bearings for this legal description is based on the Ohio State Plane-North Coordinate System NAD83 (2011). This legal description and accompanying plat represent an actual boundary survey completed under the direct supervision of Kyle J. Binkley, P.S. #8587 on September 10, 2021. All markers called for above are in place.

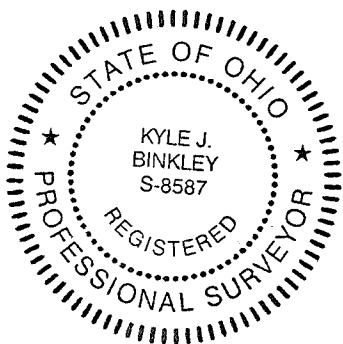

INDEXED ON MAP
8738



Richard Moldas
Page 3 of 5
September 10, 2021

Parcel "A + B"
LEGAL DESCRIPTION

Being Lot #5097 & a part of Lot #5098 of Belle Pines Subdivision, Phase II (P.C. B, Slide 102A) in the name of Richard & Sally J. Moldas (O.R. 1367, Pg. 863) and a part of a 0.793 acre tract in the name of RPM Engineering, LLC (O.R. 1393, Pg. 4139, Tract III) and being a part of V.M.S. 4478, City of Bellefontaine, Jefferson Township, Logan County, more particularly described as follows:

Beginning at an existing #5 Rebar at the NE corner of said Lot #5097 and the SE corner of Lot #4764 of Whispering Pines No. 2 (P.C. A, Slide 697A); thence the following courses:

1. N 04°-46'-39" E with the E line of said Lot #4764 and the W line of said 0.793 acre tract, 30.00' to #5 Rebar set at the NW corner of said 0.793 acre tract and the SW corner of a 5.000 acre tract in the name of David A. & Jacqueline R. Thompson (O.R. 533, Pg. 279);
2. S 84°-39'-09" E with the N line of said 0.793 acre tract and the S line of said 5.000 acre tract, 325.99' to a set #5 Rebar;
3. S 05°-02'-44" W, 60.00' to a #5 Rebar set on the S line of said 0.793 acre tract and the N line of a 5.000 acre tract in the name of Charles W. & Carol L. Stanford (O.R. 490, Pg. 429);
4. N 84°-39'-09" W with the S line of said 0.793 acre tract and the N line of said 5.000 acre tract, 325.99' to a #5 Rebar set on the E line of said Lot #5097;
5. S 05°-18'-41" W with the E line of said Lots #5097 & 5098 and the W line of said 5.000 acre tract, 164.41' to a #5 Rebar set on the E line of said Lot #5098 and the W line of said 5.000 acre tract, passing an existing #5 Rebar at the SE corner of said Lot #5097 and the NE corner of said Lot #5098 at 119.41';
6. N 84°-36'-02" W with the N line of part of Lot #5098 in the name of Ryan & April Stanley (O.R. 1398, Pg. 4935), 117.48' to a #5 Rebar set on the W line of said Lot #5098 & the E line of Belle Pines Court;
7. Northeasterly with a curve to the right and being the W line of said Lot #5098 & the E line of Belle Pines Court, having a radius of 50.00', a delta of 19°-23'-23", an arc length of 16.92', a chord bearing of N 32°-30'-57" E and a chord distance of 16.84' to a set #5 Rebar;
8. Northwesterly with a curve to the left and the W lines of said Lots #5098 & 5097 & the E line of Belle Pines Court, having a radius of 50.00', a delta of 92°-58'-16", an arc length of 81.13', a chord bearing of N 04°-16'-58" W and a chord distance of 72.52' to a point at the common corner of said Lot #5097 and Lot #5096 of said Belle Pines Subdivision;
9. N 39°-06'-04" E with the Northwesterly line of said Lot #5097 and the Southeasterly line of said Lot #5096, 129.68' to an existing #5 Rebar on the N line of said Lot #5097 and the S line of said Lot #4764, passing an existing #5 Rebar at 4.96';
10. S 84°-38'-48" E with the N line of said Lot #5097 and the S line of said Lot #4764, 49.74' to the POINT OF BEGINNING.

INDEXED ON MAP
8738

Richard Moldas
Page 4 of 5
September 10, 2021

The above described parcel contains 0.873 acres, more or less, subject to all legal highways and easements of record, with 0.449 acres in V.M.S. 4478.

The system of bearings for this legal description is based on the Ohio State Plane-North Coordinate System NAD83 (2011). This legal description and accompanying plat represent an actual boundary survey completed under the direct supervision of Kyle J. Binkley, P.S. #8587 on September 10, 2021. All markers called for above are in place.

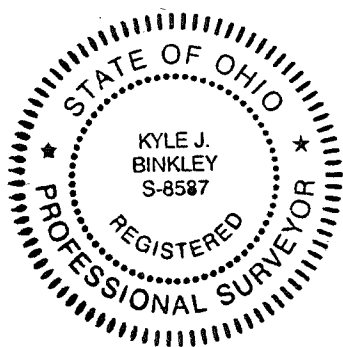

A handwritten signature in black ink, appearing to read "K. Binkley", positioned to the right of the professional seal.

INDEXED ON MAP
8738



Richard Moldas
Page 5 of 5
September 10, 2021

Parcel "C"
LEGAL DESCRIPTION

Being a part of a 0.793 acre tract in the name of RPM Engineering, LLC (O.R. 1393, Pg. 4139, Tract III) and being a part of V.M.S. 4478, City of Bellefontaine, Jefferson Township, Logan County, more particularly described as follows:

Commencing at an existing Railroad Spike at the intersection of the centerlines of Township Road 179 and White Pines Drive; thence N 05°-18'-54" E with the centerline of Township Road 179, 779.95' to a point at the POINT OF BEGINNING, as referenced by an existing 1/2" Iron Bolt at S 14°-08'-10" W, 0.30', and being the SE corner of said 0.793 acre tract and the NE corner of a 5.000 acre tract in the name of Charles W. & Carol L. Stanford (O.R. 490, Pg. 429); thence the following courses:

1. N 84°-39'-09" W with the S line of said 0.793 acre tract and the N line of said 5.000 acre tract, 400.00' to a set #5 Rebar, passing a #5 Rebar set at 30.00';
2. N 05°-02'-44" E, 60.00' to a #5 Rebar set on the N line of said 0.793 acre tract and the S line of a 5.000 acre tract in the name of David A. & Jacqueline R. Thompson (O.R. 533, Pg. 279);
3. S 84°-39'-09" E with the N line of said 0.793 acre tract and the S line of said 5.000 acre tract, 400.00' to an existing Railroad Spike at the centerline of Township Road 179 and being the NE corner of said 0.793 acre tract and the SE corner of said 5.000 acre tract, passing a set #5 Rebar at 370.00';
4. S 04°-46'-44" W with the centerline of Township Road 179, 30.00' to an existing #5 Rebar;
5. S 05°-18'-54" W with the centerline of Township Road 179, 30.00' to the POINT OF BEGINNING.

The above described parcel contains 0.551 acres, more or less, of which 0.041 acres are occupied by road right-of-way, subject to all legal highways and easements of record.

The system of bearings for this legal description is based on the Ohio State Plane-North Coordinate System NAD83 (2011). This legal description and accompanying plat represent an actual boundary survey completed under the direct supervision of Kyle J. Binkley, P.S. #8587 on September 10, 2021. All markers called for above are in place.

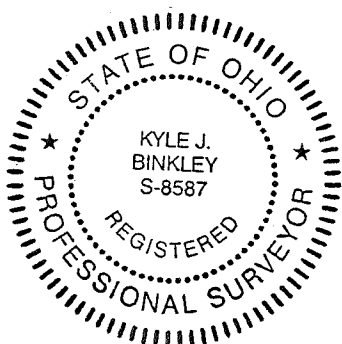

INDEXED ON MAP
8738

1-19-2023



Richard Moldas
Page 3 of 3
January 03, 2023

Parcel "A + B"
LEGAL DESCRIPTION

Being all of Lot #5164 and a part of Lot #5166 of Pinebrook Planned Unit Development (P.C. B, Slide 153A) and being located in V.M.S. 3220, City of Bellefontaine, Jefferson Township, Logan County, Ohio, (Prior Deeds Referenced in O.R. 1399, Pg. 4151 & O.R. 1411, Pg. 2600) more particularly described as follows:

Beginning at a #5 Rebar set at the NW corner of Lot #5164 and the SW corner of said Lot #5166 of said Pinebrook Planned Unit Development; thence the following courses:

1. N 05°-00'-39" E with the W line of said Lot #5166 and the E line of a 12.370 acre tract in the name of Robert A. & Gretchen J. Powell (O.R. 692, Pg. 628), 80.00' to a set #5 Rebar;
2. S 85°-10'-43" E, 181.42' to #5 Rebar set on an E line of said Lot #5166 and the W right-of-way line of Blazing Trail;
3. S 04°-51'-34" W with an E line of said Lot #5166 and the W right-of-way line of Blazing Trail, 52.95' to a set #5 Rebar;
4. Southwesterly with an E line of said Lots #5166 & 5164 and the W right-of-way line of Blazing Trail and being a curve to the right, having a radius of 120.00', an arc length of 63.39', a delta of 30°-16'-07", a chord bearing of S 19°-59'-32" W and a chord distance of 62.66' to a set #5 Rebar;
5. S 35°-07'-31" W with the E line of said Lot #5164 and the W right-of-way line of said Blazing Trail, 69.15' to a set #5 Rebar;
6. Southwesterly with the E line of said Lot #5164 and the W right-of-way line of Blazing Trail and being a curve to the right, having a radius of 120.00', an arc length of 64.76', a delta of 30°-55'-20", a chord bearing of S 50°-35'-07" W and a chord distance of 63.98' to a set #5 Rebar;
7. S 66°-02'-44" W with the E line of said Lot #5164 and the W right-of-way line of Blazing Trail, 97.13' to a #5 Rebar set at the SW corner of said Lot #5164 and the SE corner of Lot #5163 of said Pinebrook Planned Unit Development;
8. N 05°-00'-39" E with the W line of said Lot #5164, the E line of said Lot #5163 and the E line of said 12.370 acre tract, 184.51' to the POINT OF BEGINNING, passing an existing #5 Rebar at the NE corner of said Lot #5163 and the SW corner of said 12.370 acre tract at 161.88'.

The above described parcel contains 0.829 acres, more or less, subject to all legal highways and easements of record.

The system of bearings for this legal description is based on the Ohio State Plane-North Coordinate System NAD83 (2011). This legal description and accompanying plat represent an actual boundary survey completed under the direct supervision of Kyle J. Binkley, P.S. #8587 on January 03, 2023. All markers called for above are in place.

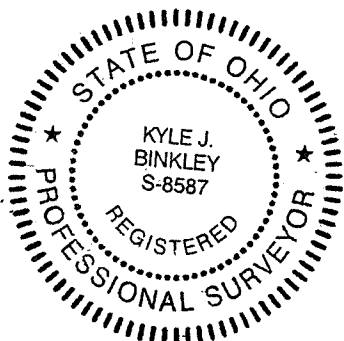

INDEXED ON MAP
8738

1-19-2023



Richard Moldas
Page 2 of 3
January 03, 2023

Parcel "A"
LEGAL DESCRIPTION

Being a part of Lot #5166 of Pinebrook Planned Unit Development (P.C. B, Slide 153A) and being located in V.M.S. 3220, City of Bellefontaine, Jefferson Township, Logan County, Ohio, (Prior Deed Referenced in O.R. 1411, Pg. 2600) more particularly described as follows:

Beginning at a #5 Rebar set at the NW corner of Lot #5164 and the SW corner of said Lot #5166 of said Pinebrook Planned Unit Development; thence the following courses:

1. N 05°-00'-39" E with the W line of said Lot #5166 and the E line of a 12.370 acre tract in the name of Robert A. & Gretchen J. Powell (O.R. 692, Pg. 628), 80.00' to a set #5 Rebar;
2. S 85°-10'-43" E, 181.42' to #5 Rebar set on an E line of said Lot #5166 and the W right-of-way line of Blazing Trail;
3. S 04°-51'-34" W with an E line of said Lot #5166 and the W right-of-way line of Blazing Trail, 52.95' to a set #5 Rebar;
4. Southwesterly with an E line of said Lot #5166 and the W right-of-way line of Blazing Trail and being a curve to the right, having a radius of 120.00', an arc length of 27.29', a delta of 13°-01'-46", a chord bearing of S 11°-22'-21" W and a chord distance of 27.23' to a point at the SE corner of said Lot #5166 and the NE corner of said Lot #5164;
5. N 85°-10'-43" W with the S line of said Lot #5166 and the N line of said Lot #5164, 178.55' to the POINT OF BEGINNING.

The above described parcel contains 0.333 acres, more or less, subject to all legal highways and easements of record.

The system of bearings for this legal description is based on the Ohio State Plane-North Coordinate System NAD83 (2011). This legal description and accompanying plat represent an actual boundary survey completed under the direct supervision of Kyle J. Binkley, P.S. #8587 on January 03, 2023. All markers called for above are in place.

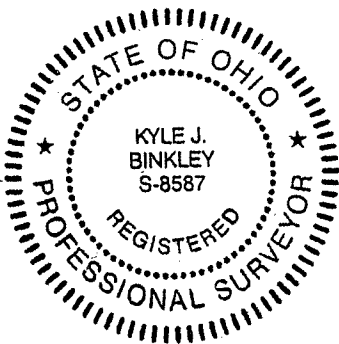

INDEXED ON MAP
8738

1-19-2023

APPROVED

Survey of Parcel #61-092-00-00-020-021 and being Lot #5164 and a part of Parcel #61-092-00-00-020-023 and being Lot #5166 of Pinebrook Planned Unit Development (P.B. C, Slide 153A) and being located in V.M.S. 3220, City of Bellefontaine, Jefferson Township, Logan County, Ohio.

(Prior Deeds Referenced in O.R. 1399, Pg. 4151 & O.R. 1411, Pg. 2600)

Robert A. & Gretchen J. Powell
O.R. 692, Pg. 628
(12.370 acres)

Pt. of Lot #5166
Robert M. Ray III & Tonya J. Abrego
O.R. 1411, Pg. 2600

Parcel "A + B"
(Total - 0.829 acres)

Parcel "A"
Pt. of Lot #5166
Robert M. Ray III & Tonya J. Abrego
O.R. 1411, Pg. 2600
(0.333 acres)

Pt. of Lot #5166
Robert M. Ray III & Tonya J. Abrego
O.R. 1411, Pg. 2600

Lot #5163
Carla Stephen & Cheryl Schroeder Co-Trustees
O.R. 1406, Pg. 4162

Parcel "B"
Lot #5164
Jason D. & Tonya M. Benton
O.R. 1399, Pg. 4151
(0.496 acres - Plat)

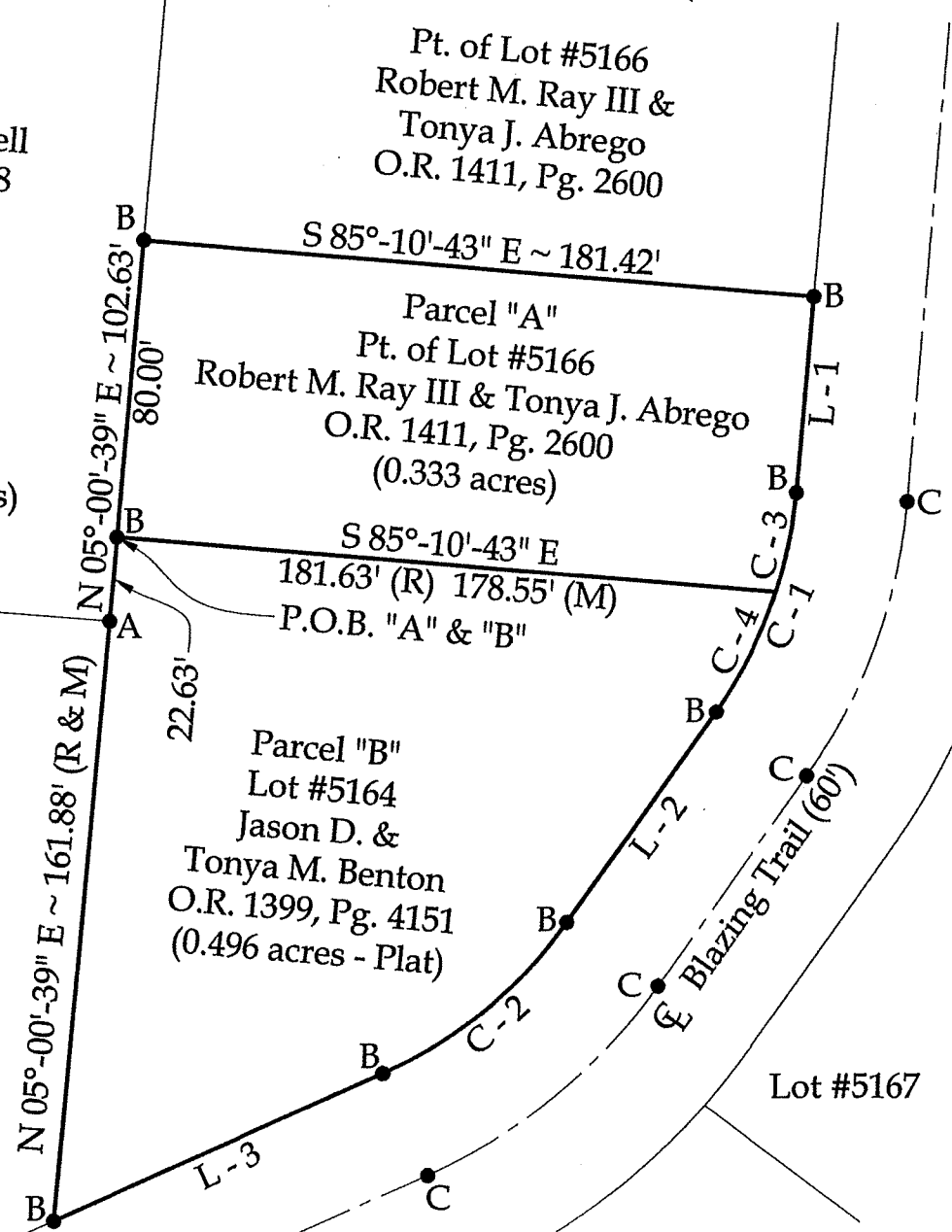

Legend

- A = Existing #5 Rebar
- B = Set #5 Rebar
- C = Set Mag Nail

Line Data

- L - 1 = S 04°-51'-34" W ~ 52.95'
- L - 2 = S 35°-07'-31" W ~ 69.15' (R & M)
- L - 3 = S 66°-02'-44" W ~ 97.13' (R & M)

Curve Data

(C - 1)
Radius = 120.00'
Arc Length = 63.39'
Chord Distance = 62.66'
Chord Bearing = S 19°-59'-32" W
Delta = 30°-16'-07"

(C - 2)
Radius = 120.00'
Arc Length = 64.76'
Chord Distance = 63.98'
Chord Bearing = S 50°-35'-07" W
Delta = 30°-55'-20"

(C - 3)
Radius = 120.00'
Arc Length = 27.29'
Chord Distance = 27.23'
Chord Bearing = S 11°-22'-21" W
Delta = 13°-01'-46"

(C - 4)
Radius = 120.00'
Arc Length = 36.11'
Chord Distance = 35.97'
Chord Bearing = S 26°-30'-21" W
Delta = 17°-14'-22"

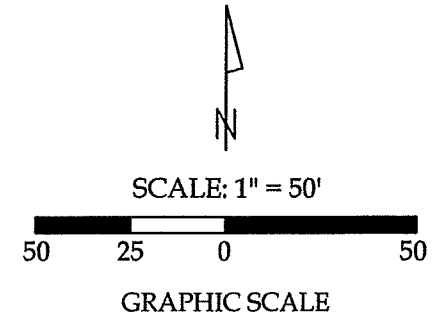

This plat and the accompanying legal descriptions represent an actual boundary survey completed under my direct supervision on January 03, 2023.

Kyle J. Binkley, P.S. #8587

Binkley
LAND SURVEYING, LLC
121 W. Auglaize Street
Wapakoneta, Ohio 45895
(419) 236-3768

NOTE: All distances on this plat are measured unless otherwise noted.

BASIS OF BEARINGS: The system of bearings for this plat and legal description is based on the Ohio State Plane - North Coordinate System NAD83 (2011).

Surveyor's Note: The Pinebrook PUD platted Lot #5164 has a 3.08' error of closure. Therefore, the platted centerline along with found monumentation along State Route 33 (as called out per plat) was held to recreate the area.

INDEXED ON MAP
8738

CLIENT: Richard Moldas			
SURVEYED BY: T.J.S./T.E.W.	DATE: 01-03-2023	DRAWN BY: K.J.B.	CHECKED BY: K.J.B.
SCALE: 1" = 50'	PAGE 1	OF 1	PAGES 3