



# Lee Surveying and Mapping Co.



Farm Surveys • Lot Surveys • Topography • Subdivisions • Construction Layout

143 EAST COLUMBUS AVENUE  
BELLEFONTAINE, OHIO 43311

(513) 593-7335  
(513) 593-5780

CLAYTON M. LEE, P.S.  
JEFFREY I. LEE, P.S.

## ESTHER PATTERSON SURVEY

LYING IN V.M.S. 7318, MONROE AND JEFFERSON TOWNSHIPS, LOGAN COUNTY, OHIO.

BEING THAT 7.5 ACRE TRACT (BY DEED) LYING IN THE NAME OF ESTHER PATTERSON AS DEEDED AND DESCRIBED IN VOLUME 355, PAGE 594 OF THE LOGAN COUNTY RECORDS OF DEEDS AND BEING MORE PARTICULARLY DESCRIBED AS FOLLOWS:

BEGINNING AT A 5/8 INCH IRON ROD FOUND AT AN ANGLE IN THE CENTER-LINE OF TOWNSHIP ROAD 147 AND THE SOUTH LINE OF V.M.S. 7318, S 21°-34'-00" E, A DISTANCE OF 100.00 FEET FROM A 5/8 INCH IRON ROD FOUND AT THE INTERSECTION OF THE CENTER-LINE OF TOWNSHIP ROAD 147 AND THE NORTH LINE OF MONROE TOWNSHIP.

THENCE, WITH THE SOUTH LINE OF V.M.S. 7318 AND THE NORTH LINE OF V.M.S. 4676, S 67°-51'-08" W, A DISTANCE OF 471.96 FEET TO A 5/8 INCH IRON ROD SET IN THE EAST LINE OF THE J. REAMES 21.5 ACRE TRACT (VOL. 390, PG. 704, TRACT 3).

THENCE, N 21°-32'-56" W, A DISTANCE OF 658.02 FEET TO A STONE FOUND AT THE NORTHEAST CORNER OF THE SAID 21.5 ACRE TRACT.

THENCE, WITH THE SOUTH LINE OF THE H. BARNES 68.99 ACRE TRACT (VOL. 288, PG. 227, TRACT 2), N 69°-47'-52" E, A DISTANCE OF 471.87 FEET TO A RAILROAD SPIKE SET ON THE CENTER-LINE OF TOWNSHIP ROAD 147.

THENCE, WITH THE CENTER-LINE OF TOWNSHIP ROAD 147, S 21°-34'-00" E, A DISTANCE OF 642.00 FEET TO THE POINT OF BEGINNING.

CONTAINING 7.041 ACRES OF WHICH 5.021 ACRES ARE IN JEFFERSON TOWNSHIP AND 2.020 ACRES ARE IN MONROE TOWNSHIP. 0.295 ACRE IS WITHIN THE ROAD RIGHT-OF-WAY.

THE BASIS FOR BEARINGS IS BASED UPON THE CENTER-LINE OF TOWNSHIP ROAD BEING S 21°-34'-00" E, AND ALL OTHER BEARINGS AND DISTANCES ARE FROM ANGLES AND DISTANCES MEASURED IN A FIELD SURVEY BY LEE SURVEYING AND MAPPING COMPANY ON JUNE 26, 1990.

DESCRIPTION PREPARED BY:

*Jeffrey I. Lee*  
JEFFREY I. LEE  
PROFESSIONAL SURVEYOR 6359  
JUNE 26, 1990



ORIGINAL STAMP IN GREEN

INDEXED ON MAP  
8045 ID

L-1191

H. BARNES  
 68.99 AC.  
 VOL. 288, PG. 227, TR. 2

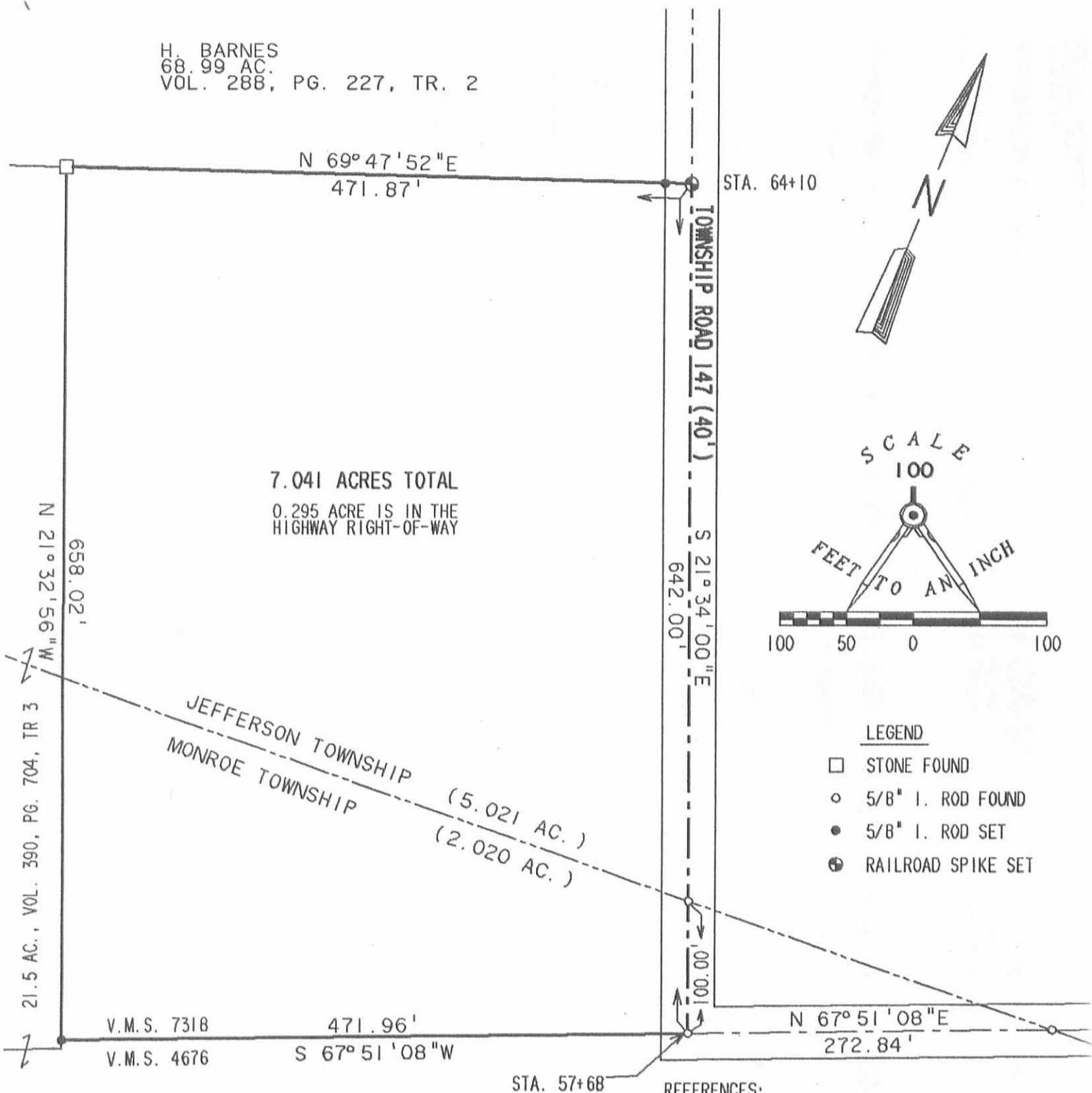

J. REAMES  
 22.82 AC.  
 VOL. 390, PG. 704, TR. 2

REFERENCES:

LOGAN COUNTY ENGINEER'S FIELD BOOK 451, PG. 33  
 LOGAN COUNTY ENGINEER'S FIELD BOOK 573, PG. 59

RETRACEMENT SURVEY OF THE  
 ESTHER PATTERSON 7.5 ACRE TRACT (DEED)  
 7.041 ACRES BY THIS SURVEY  
 VOLUME 355, PAGE 594  
 V.M.S. 7318  
 JEFFERSON AND MONROE TOWNSHIPS  
 LOGAN COUNTY, OHIO

NOTE: THIS PROPERTY MAY BE SUBJECT TO A  
 16.5 FEET WIDE EASEMENT MENTIONED  
 IN DEED VOL. 390, PG. 704, TRACT 3.

INDEXED ON MAP  
 80451P

SURVEYED BY:  
*Jeffrey A. Lee*  
 JEFFREY A. LEE  
 PROFESSIONAL SURVEYOR 6359  
 JUNE 26, 1990  
 LEE SURVEYING & MAPPING CO.  
 143 East Columbus Avenue  
 BELLEFONTAINE, OHIO 43311  
 (513) 593-7335

ORIGINAL STAMP IN GREEN

# Lee Surveying and Mapping Co., Inc.

Land Surveys • Topography • Subdivisions • Construction Layout

117 N. Madriver St.  
Bellefontaine OH 43311



Phone: (937) 593-7335  
Fax: (937) 593-7444  
surveys@lsminc.us

## REAMES 63.342 ACRES

Lying in Virginia Military Surveys 7318, 4676 and 4497, Jefferson and Monroe Townships, Logan County, Ohio.

Being all of the Jerry M. Reames and David B. Reames 40 acre tract and 21.50 acre tract as deeded and described in Official Record 650, Page 527, Tract II and Tract III of the Logan County Records of Deeds and being more particularly described as follows:

Beginning on a 5/8 inch iron rod found on the south line of Virginia Military Survey 7318, the north line of Virginia Military Survey 4676 and on an angle point on the center-line of Township Road 147 in Jefferson Township.

THENCE, with the center-line of Township Road 147 (50 feet wide), S 15°-06'-53"E, a distance of 683.78 feet to a railroad spike found, passing a MAG nail found at 35.33 feet and a square head lag bolt found at 382.59 feet.

THENCE, with the south line of Virginia Military Survey 4497 extended and the south line of Virginia Military Survey 4497, the north line of Virginia Military Survey 4676 extended and the north line of Virginia Military Survey 4676 and the north lines of the Rebecca D. Porter 3 acre tract (O.R. 403, Pg. 225), the John J. Porter original 17.640 acre tract (O.R. 186, Pg. 881) and the Brent D. Boots 82.36 acre tract (O.R. 444, Pg. 953), S 73°-31'-40"W, a distance of 2609.72 feet to a point in the center of a creek, passing a 5/8 inch iron rod set at 25.01 feet, 5/8 inch iron rod found at 174.22 feet and 1018.53 feet and a 5/8 inch iron rod set at 2571.38 feet.

THENCE, with the center-line of the creek and the east lines of the Robert Earl Devore 91.35 acre tract (O.R. 223, Pg. 603, First Tract), the following twenty six courses:

N 49°-59'-53"W, a distance of 77.50 feet to a point, referenced by a 5/8 inch iron rod set bearing N 86°-49'-18"E, a distance of 44.87 feet.

N 19°-57'-29"E, a distance of 126.70 feet to a point, referenced by a 5/8 inch iron rod set bearing N 58°-49'-19"E, a distance of 12.37 feet.

N 76°-55'-16"W, a distance of 86.76 feet to a point, referenced by a 5/8 inch iron rod set bearing N 80°-45'-12"E, a distance of 24.65 feet.

N 33°-00'-43"E, a distance of 112.17 feet to a point, referenced by a 5/8 inch iron rod set bearing S 19°-00'-37"E, a distance of 28.11 feet.

N 59°-23'-46"E, a distance of 78.04 feet to a point, referenced by a 5/8 inch iron rod set bearing S 75°-27'-29"E, a distance of 8.14 feet.

N 41°-59'-58"W, a distance of 73.60 feet to a point, referenced by a 5/8 inch iron rod set bearing N 42°-10'-19"E, a distance of 19.86 feet.

N 82°-25'-24"W, a distance of 65.48 feet to a 5/8 inch iron rod set.

N 13°-05'-06"E, a distance of 99.05 feet to a point, referenced by a 5/8 inch iron rod set bearing N 52°-54'-21"E, a distance of 13.80 feet.

N 76°-58'-40"W, a distance of 57.79 feet to a point, referenced by a 5/8 inch iron rod set bearing N 62°-08'-32"E, a distance of 34.83 feet.

N 01°-25'-33"W, a distance of 52.76 feet to a point, referenced by a 5/8 inch iron rod set bearing N 83°-18'-32"E, a distance of 14.57 feet.

# Lee Surveying and Mapping Co., Inc.

Land Surveys • Topography • Subdivisions • Construction Layout

117 N. Madriver St.  
Bellefontaine OH 43311



Phone: (937) 593-7335  
Fax: (937) 593-7444  
surveys@lsminc.us

N 25°-15'-32"W, a distance of 67.74 feet to a point, referenced by a 5/8 inch iron rod set bearing N 80°-06'-27"E, a distance of 20.16 feet.

N 12°-12'-01"E, a distance of 78.88 feet to a point, referenced by a 5/8 inch iron rod set bearing S 50°-23'-48"E, a distance of 14.92 feet.

N 31°-02'-12"E, a distance of 55.62 feet to a point, referenced by a 5/8 inch iron rod set bearing S 56°-58'-10"E, a distance of 13.02 feet.

N 09°-54'-53"W, a distance of 107.33 feet to a point, referenced by a 5/8 inch iron rod set bearing S 58°-42'-14"E, a distance of 9.46 feet.

N 55°-00'-42"E, a distance of 97.86 feet to a point, referenced by a 5/8 inch iron rod set bearing N 73°-57'-16"E, a distance of 9.50 feet.

N 29°-02'-45"W, a distance of 47.44 feet to a point, referenced by a 5/8 inch iron rod set bearing S 80°-03'-56"E, a distance of 12.26 feet.

N 20°-10'-00"E, a distance of 33.75 feet to a point, referenced by a 5/8 inch iron rod set bearing S 65°-17'-53"E, a distance of 10.42 feet.

N 48°-37'-40"E, a distance of 103.08 feet to a point, referenced by a 5/8 inch iron rod set bearing S 78°-58'-55"E, a distance of 4.60 feet.

N 54°-43'-27"W, a distance of 13.77 feet to a point, referenced by a 5/8 inch iron rod set bearing N 43°-36'-04"E, a distance of 6.22 feet.

N 28°-26'-52"E, a distance of 90.35 feet to a point, referenced by a 5/8 inch iron rod set bearing S 22°-00'-46"E, a distance of 16.89 feet.

S 88°-17'-10"E, a distance of 100.30 feet to a point, referenced by a 5/8 inch iron rod set bearing S 32°-25'-11"E, a distance of 17.12 feet.

N 15°-31'-57"W, a distance of 128.46 feet to a point, referenced by a 5/8 inch iron rod set bearing S 81°-21'-55"E, a distance of 28.69 feet.

N 20°-18'-18"E, a distance of 99.33 feet to a point, referenced by a 5/8 inch iron rod set bearing S 05°-41'-22"E, a distance of 10.91 feet.

N 45°-53'-54"E, a distance of 68.23 feet to a point, referenced by a 5/8 inch iron rod set bearing S 30°-24'-37"E, a distance of 7.66 feet.

N 43°-09'-10"W, a distance of 68.36 feet to a point, referenced by a 5/8 inch iron rod set bearing N 15°-22'-38"E, a distance of 12.01 feet.

N 84°-04'-23"W, a distance of 144.01 feet to a point.

THENCE, with the south lines of the Jeffrey S. John 30 acre tract (O.R. 866, Pg. 262) and the Shane D. Boyssel 68.56 acre tract (O.R. 456, Pg. 685, Tract II), N 75°-24'-31"E, a distance of 1369.16 feet to a point referenced by a 5/8 inch iron rod found bearing N 15°-41'-01"W, a distance of 0.61 feet, passing a 5/8 inch iron rod set at 14.00 feet.

THENCE, with the west line of the Orville L. Overmyer 7.041 acre tract (O.R. 109, Pg. 461), S 15°-41'-01"E, a distance of 656.02 feet to a 5/8 inch iron rod found on the south line of Virginia Military Survey 7318 and the north line of Virginia Military Survey 4676.

THENCE, with the south line of Virginia Military Survey 7318 and the north line of Virginia Military Survey 4676 and the south line of the said 7.041 acre tract,

# Lee Surveying and Mapping Co., Inc.

Land Surveys • Topography • Subdivisions • Construction Layout

117 N. Madriver St.  
Bellefontaine OH 43311

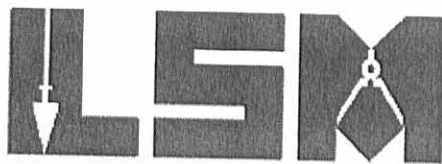

Phone: (937) 593-7335  
Fax: (937) 593-7444  
surveys@lsminc.us

N 73°-42'-53"E, a distance of 471.96 feet to a 5/8 inch iron rod found on the center-line of Township Road 147 at an angle point, passing a 5/8 inch iron rod set at 446.96 feet.

THENCE, with the south line of Virginia Military Survey 7318 and the north line of Virginia Military Survey 4676 and the center-line of Township Road 147, N 73°-42'-53"E, a distance of 370.30 feet to the point of beginning, passing a MAG nail found at 272.82 feet.

Containing 63.342 acres, of which 0.605 acre is within the highway right-of-way. There are 9.545 acres in Virginia Military Survey 7318, 22.735 acres in Virginia Military Survey 4676 and 31.062 acres in Virginia Military Survey 4497. There are 5.106 acres in Jefferson Township and 58.236 acres in Monroe Township.

The basis for bearings is the south line of Virginia Military Survey 7318, being N 73°-42'-53"E, and all other bearings are from angles and distances measured in a field survey by Lee Surveying and Mapping Co., Inc. on May 19, 2009.



ORIGINAL STAMP IN GREEN

Description prepared by:

*William K. Bruce*

William K. Bruce  
Professional Surveyor 7437  
May 22, 2009

4790059

INDEXED ON MAP  
8045 20-3

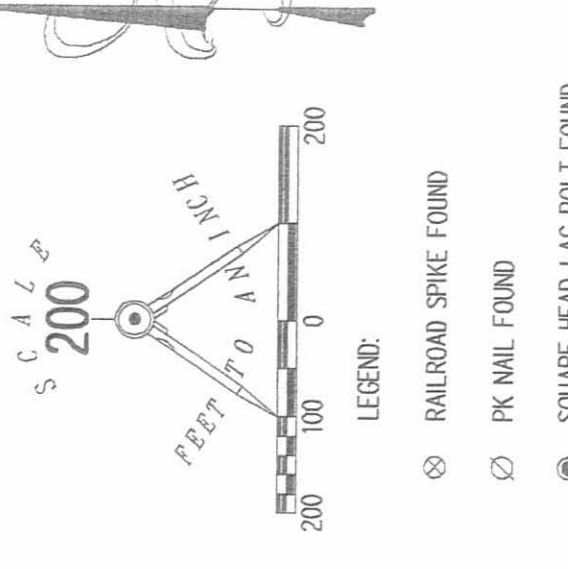

- LEGEND:
- ⊗ RAILROAD SPIKE FOUND
  - ⊙ PK NAIL FOUND
  - ⊕ SQUARE HEAD LAG BOLT FOUND
  - 5/8 INCH IRON ROD FOUND
  - 5/8 INCH IRON ROD SET
  - ⊙ 1 INCH IRON PIPE FOUND
  - ⊕ MAG NAIL FOUND

ARTHUR C. METZ  
ORIGINAL SURVEY  
VOL. 246, PG. 294  
TRACT II

VIRGINIA MILITARY SURVEY 5812  
VIRGINIA MILITARY SURVEY 7318

THOMAS E. MITCHELL  
5339 ACRES  
O.R. 468, PG. 115

THOMAS E. MITCHELL  
5339 ACRES  
O.R. 468, PG. 115

SURVEY OF TWO TRACTS OUT OF THE  
JERRY M. REAMES AND  
DAVID B. REAMES  
43.364 ACRE TRACT, 5.893 ACRE TRACT,  
40 ACRE TRACT, 21.50 ACRE TRACT  
AND 28 ACRE TRACT  
OFFICIAL RECORD 650, PAGE 527  
TRACT I, PARCEL 1 AND PARCEL 2,  
TRACT II, TRACT III AND TRACT IV  
VIRGINIA MILITARY SURVEYS  
7318, 4676 AND 4497  
JEFFERSON AND MONROE TOWNSHIP  
LOGAN COUNTY, OHIO



COPYRIGHT 2009 BY:  
LEE SURVEYING & MAPPING CO., INC.  
1000 BELLEVILLE AVE., SUITE 100  
JEFFERSON, OHIO 43131  
(937) 593-7335  
SURVEYS@lsmc.com  
ISS 00509 4790059 L-4790-1

ARTHUR C. METZ  
ORIGINAL 50 AND 1/4 ACRES  
VOL. 246, PG. 294  
TRACT I

ARTHUR C. METZ  
ORIGINAL 50 AND 1/4 ACRES  
VOL. 246, PG. 294  
TRACT I

43.364 ACRES  
TRACT I, PARCEL 1  
(42.680 ACRES)

78.158 ACRES  
OF WHICH 0.608 ACRE IS WITHIN  
THE HIGHWAY RIGHT-OF-WAY

63.342 ACRES  
OF WHICH 0.605 ACRE IS WITHIN  
THE HIGHWAY RIGHT-OF-WAY

TOWNSHIP ROAD 147 (50')

TOWNSHIP ROAD 147 (50')

VIRGINIA MILITARY SURVEY 7318  
VIRGINIA MILITARY SURVEY 4497  
VIRGINIA MILITARY SURVEY 4676  
VIRGINIA MILITARY SURVEY 4676

JEFFREY S. JOHN  
1,021 ACRES  
11,002 ACRES  
O.R. 866, PG. 282

21.50 ACRES  
TRACT III  
(22.468 ACRES)

40 ACRES  
TRACT II  
(40.874 ACRES)

JOHN J. PORTER  
ORIGINAL 17,640 ACRES  
O.R. 186, PG. 881

BRENT D. BOOTS  
82.36 ACRES  
O.R. 444, PG. 953

- ADJOINERS
- 1 KIMBERLY K. REAMES  
1,136 ACRES  
O.R. 601, PG. 660
  - 2 BRIAN J. REAMES  
1,286 ACRES  
O.R. 660, PG. 978
  - 3 JERRY M. REAMES  
1,287 ACRES  
O.R. 63, PG. 280

CHORDS TO POINTS IN  
CENTER OF CREEK

LINE	BEARING	DISTANCE
L1	N 49°59'53" W	77.50
L2	N 18°57'29" E	126.70
L3	N 76°56'16" W	86.76
L4	N 33°00'43" E	112.17
L5	N 58°23'46" E	78.04
L6	N 41°59'58" W	73.60
L7	N 82°25'24" W	65.48
L8	N 13°06'06" E	99.05
L9	N 76°58'40" W	57.79
L10	N 01°25'33" W	52.76
L11	N 25°15'32" W	67.74
L12	N 12°12'01" E	78.88
L13	N 31°02'12" E	55.62
L14	N 09°54'53" W	107.33
L15	N 55°00'42" E	97.86
L16	N 29°02'45" W	47.44
L17	N 20°10'07" E	33.75
L18	N 48°37'40" E	103.08
L19	N 54°43'27" W	13.77
L20	N 28°26'52" E	90.35
L21	S 88°17'10" E	100.30
L22	N 15°51'57" W	128.46
L23	N 20°18'18" E	34.83
L24	N 45°53'54" E	89.33
L25	N 43°09'10" W	68.36
L26	N 84°04'23" W	144.01

BEARINGS AND DISTANCES FROM  
CENTER-LINE OF CREEK TO  
REFERENCE MONUMENT

LINE	BEARING	DISTANCE
L27	N 86°49'18" E	44.87
L28	N 58°49'19" E	12.37
L29	N 80°45'12" E	24.65
L30	S 19°00'37" E	28.11
L31	S 72°27'29" E	8.14
L32	N 42°10'19" E	19.86
L33	N 52°54'21" E	13.80
L34	N 62°08'32" E	34.83
L35	N 83°18'32" E	14.57
L36	N 80°06'27" E	20.16
L37	S 50°23'48" E	14.92
L38	S 56°59'10" E	13.02
L39	S 58°42'14" E	9.46
L40	N 73°57'16" E	9.50
L41	S 80°03'56" E	12.26
L42	S 65°17'53" E	10.42
L43	S 78°59'55" E	4.60
L44	N 43°56'04" E	6.22
L45	S 22°07'46" E	16.89
L46	S 22°25'11" E	17.12
L47	S 81°21'35" E	28.89
L48	S 05°41'22" E	10.91
L49	S 30°24'37" E	7.66
L50	N 15°22'38" E	12.01

CREEK DETAIL

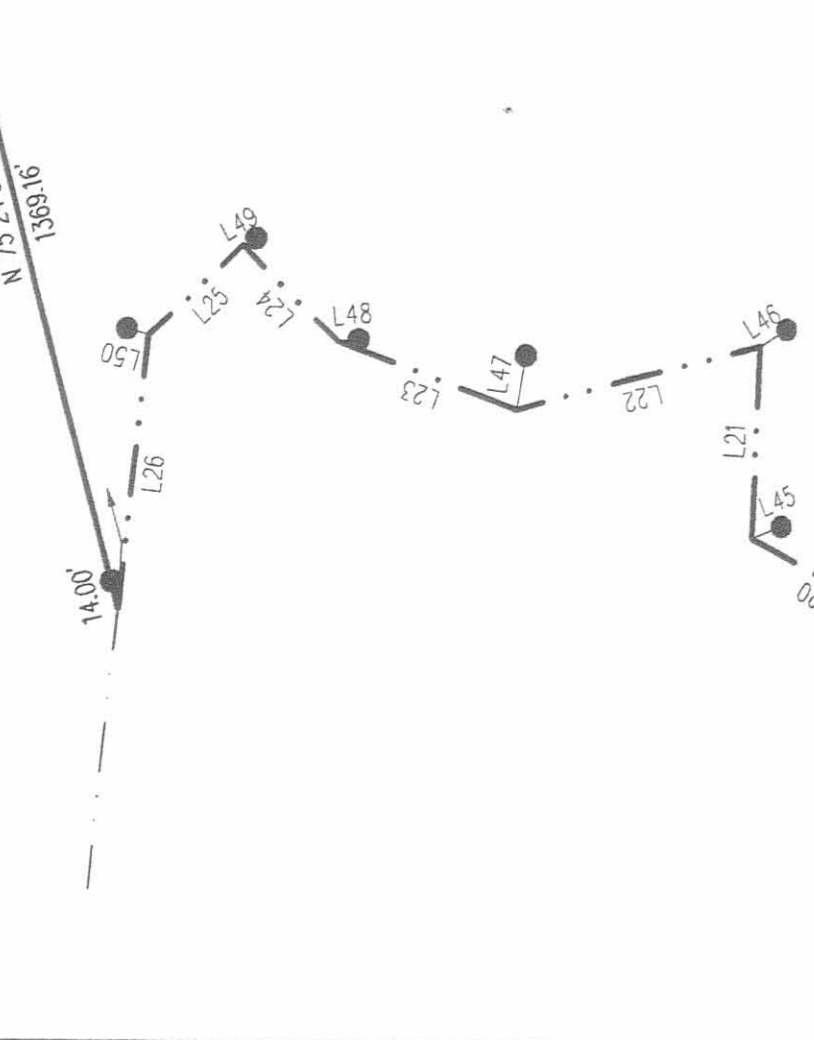

ROBERT EARL DEVORE  
91.35 ACRES  
O.R. 223, PG. 603  
FIRST TRACT

ROBERT EARL DEVORE  
91.35 ACRES  
O.R. 223, PG. 603  
FIRST TRACT

SEE CREEK DETAIL

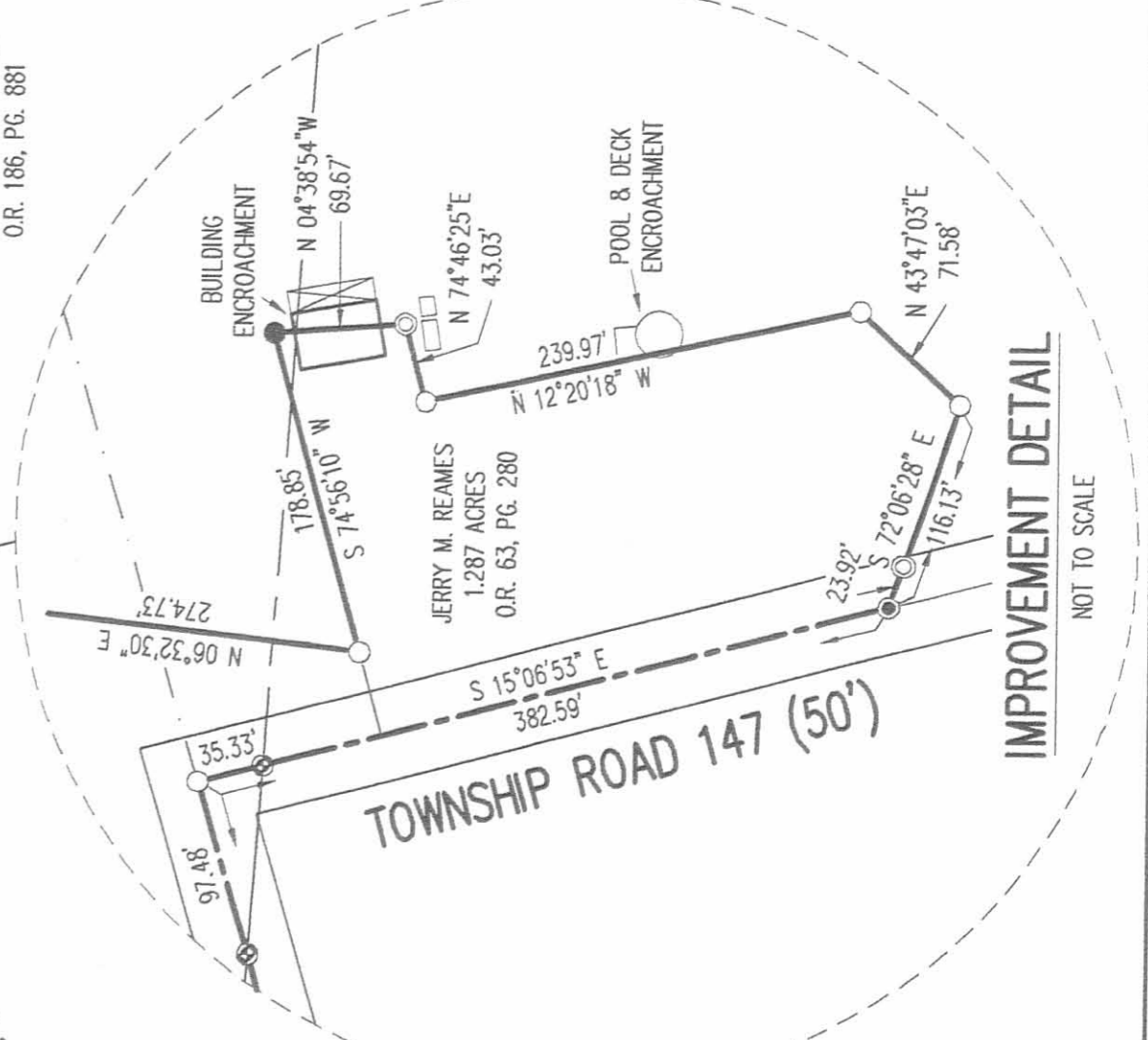

IMPROVEMENT DETAIL

NOT TO SCALE

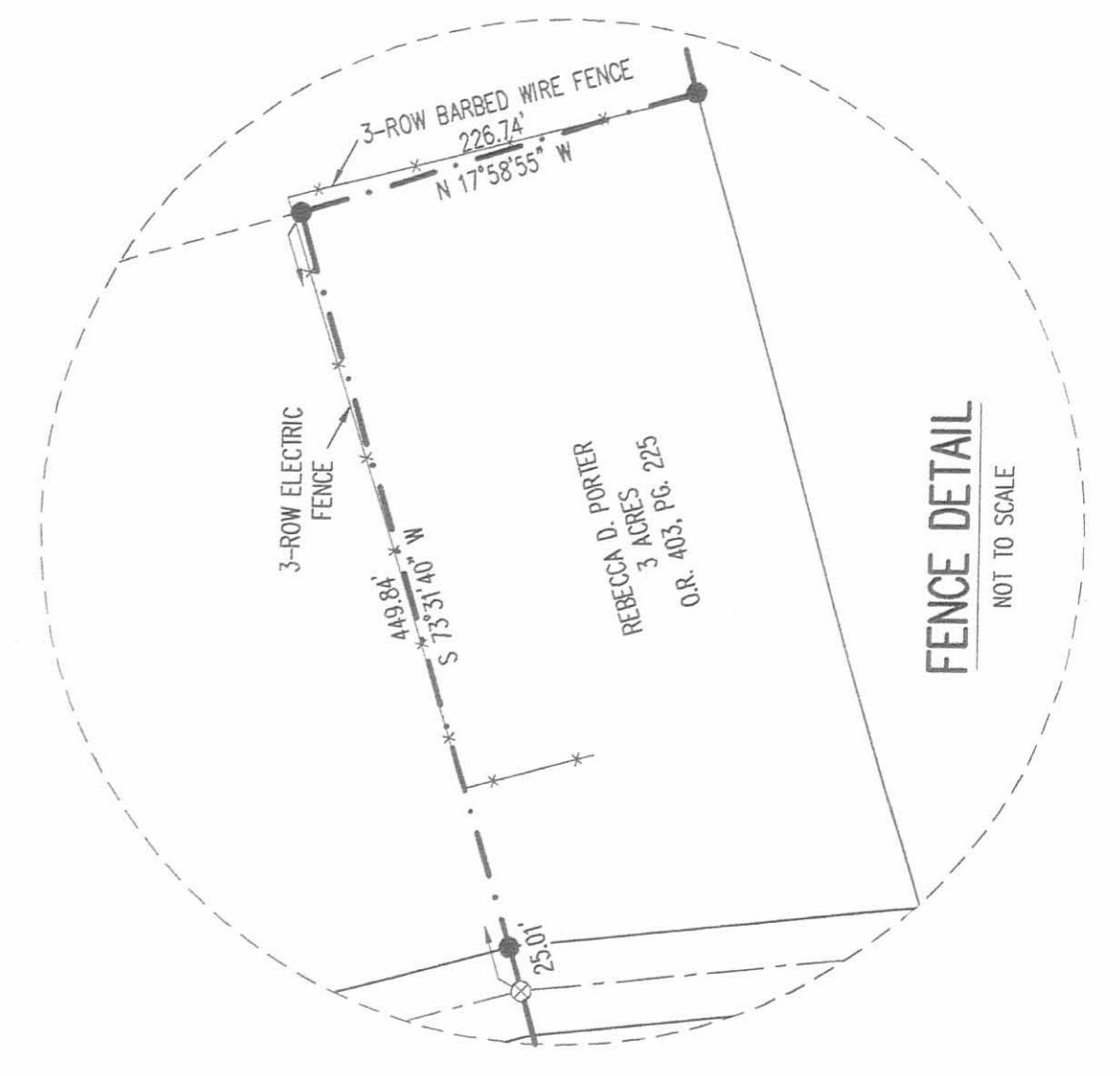

FENCE DETAIL

NOT TO SCALE

2 WORKING DAYS  
BEFORE YOU DIG  
CALL TOLL FREE 800-362-2764  
OR VISIT US ONLINE AT WWW.804S.COM

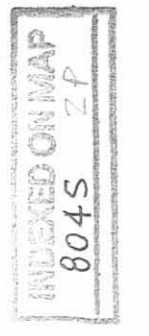

# Lee Surveying and Mapping Co., Inc.

Land Surveys • Topography • Subdivisions • Construction Layout

117 N. Madriver St.  
Bellefontaine OH 43311



Phone: (937) 593-7335  
Fax: (937) 593-7444  
surveys@lsminc.us

## REAMES 63.342 ACRES

Lying in Virginia Military Surveys 7318, 4676 and 4497, Jefferson and Monroe Townships, Logan County, Ohio.

Being all of the Jerry M. Reames and David B. Reames 40 acre tract and 21.50 acre tract as deeded and described in Official Record 650, Page 527, Tract II and Tract III of the Logan County Records of Deeds and being more particularly described as follows:

Beginning on a 5/8 inch iron rod found on the south line of Virginia Military Survey 7318, the north line of Virginia Military Survey 4676 and on an angle point on the center-line of Township Road 147 in Jefferson Township.

THENCE, with the center-line of Township Road 147 (50 feet wide), S 15°-06'-53"E, a distance of 683.78 feet to a railroad spike found, passing a MAG nail found at 35.33 feet and a square head lag bolt found at 382.59 feet.

THENCE, with the south line of Virginia Military Survey 4497 extended and the south line of Virginia Military Survey 4497, the north line of Virginia Military Survey 4676 extended and the north line of Virginia Military Survey 4676 and the north lines of the Rebecca D. Porter 3 acre tract (O.R. 403, Pg. 225), the John J. Porter original 17.640 acre tract (O.R. 186, Pg. 881) and the Brent D. Boots 82.36 acre tract (O.R. 444, Pg. 953), S 73°-31'-40"W, a distance of 2609.72 feet to a point in the center of a creek, passing a 5/8 inch iron rod set at 25.01 feet, 5/8 inch iron rod found at 174.22 feet and 1018.53 feet and a 5/8 inch iron rod set at 2571.38 feet.

THENCE, with the center-line of the creek and the east lines of the Robert Earl Devore 91.35 acre tract (O.R. 223, Pg. 603, First Tract), the following twenty six courses:

N 49°-59'-53"W, a distance of 77.50 feet to a point, referenced by a 5/8 inch iron rod set bearing N 86°-49'-18"E, a distance of 44.87 feet.

N 19°-57'-29"E, a distance of 126.70 feet to a point, referenced by a 5/8 inch iron rod set bearing N 58°-49'-19"E, a distance of 12.37 feet.

N 76°-55'-16"W, a distance of 86.76 feet to a point, referenced by a 5/8 inch iron rod set bearing N 80°-45'-12"E, a distance of 24.65 feet.

N 33°-00'-43"E, a distance of 112.17 feet to a point, referenced by a 5/8 inch iron rod set bearing S 19°-00'-37"E, a distance of 28.11 feet.

N 59°-23'-46"E, a distance of 78.04 feet to a point, referenced by a 5/8 inch iron rod set bearing S 75°-27'-29"E, a distance of 8.14 feet.

N 41°-59'-58"W, a distance of 73.60 feet to a point, referenced by a 5/8 inch iron rod set bearing N 42°-10'-19"E, a distance of 19.86 feet.

N 82°-25'-24"W, a distance of 65.48 feet to a 5/8 inch iron rod set.

N 13°-05'-06"E, a distance of 99.05 feet to a point, referenced by a 5/8 inch iron rod set bearing N 52°-54'-21"E, a distance of 13.80 feet.

N 76°-58'-40"W, a distance of 57.79 feet to a point, referenced by a 5/8 inch iron rod set bearing N 62°-08'-32"E, a distance of 34.83 feet.

N 01°-25'-33"W, a distance of 52.76 feet to a point, referenced by a 5/8 inch iron rod set bearing N 83°-18'-32"E, a distance of 14.57 feet.

# Lee Surveying and Mapping Co., Inc.

Land Surveys • Topography • Subdivisions • Construction Layout

117 N. Madriver St.  
Bellefontaine OH 43311



Phone: (937) 593-7335  
Fax: (937) 593-7444  
surveys@lsminc.us

N 25°-15'-32"W, a distance of 67.74 feet to a point, referenced by a 5/8 inch iron rod set bearing N 80°-06'-27"E, a distance of 20.16 feet.

N 12°-12'-01"E, a distance of 78.88 feet to a point, referenced by a 5/8 inch iron rod set bearing S 50°-23'-48"E, a distance of 14.92 feet.

N 31°-02'-12"E, a distance of 55.62 feet to a point, referenced by a 5/8 inch iron rod set bearing S 56°-58'-10"E, a distance of 13.02 feet.

N 09°-54'-53"W, a distance of 107.33 feet to a point, referenced by a 5/8 inch iron rod set bearing S 58°-42'-14"E, a distance of 9.46 feet.

N 55°-00'-42"E, a distance of 97.86 feet to a point, referenced by a 5/8 inch iron rod set bearing N 73°-57'-16"E, a distance of 9.50 feet.

N 29°-02'-45"W, a distance of 47.44 feet to a point, referenced by a 5/8 inch iron rod set bearing S 80°-03'-56"E, a distance of 12.26 feet.

N 20°-10'-00"E, a distance of 33.75 feet to a point, referenced by a 5/8 inch iron rod set bearing S 65°-17'-53"E, a distance of 10.42 feet.

N 48°-37'-40"E, a distance of 103.08 feet to a point, referenced by a 5/8 inch iron rod set bearing S 78°-58'-55"E, a distance of 4.60 feet.

N 54°-43'-27"W, a distance of 13.77 feet to a point, referenced by a 5/8 inch iron rod set bearing N 43°-36'-04"E, a distance of 6.22 feet.

N 28°-26'-52"E, a distance of 90.35 feet to a point, referenced by a 5/8 inch iron rod set bearing S 22°-00'-46"E, a distance of 16.89 feet.

S 88°-17'-10"E, a distance of 100.30 feet to a point, referenced by a 5/8 inch iron rod set bearing S 32°-25'-11"E, a distance of 17.12 feet.

N 15°-31'-57"W, a distance of 128.46 feet to a point, referenced by a 5/8 inch iron rod set bearing S 81°-21'-55"E, a distance of 28.69 feet.

N 20°-18'-18"E, a distance of 99.33 feet to a point, referenced by a 5/8 inch iron rod set bearing S 05°-41'-22"E, a distance of 10.91 feet.

N 45°-53'-54"E, a distance of 68.23 feet to a point, referenced by a 5/8 inch iron rod set bearing S 30°-24'-37"E, a distance of 7.66 feet.

N 43°-09'-10"W, a distance of 68.36 feet to a point, referenced by a 5/8 inch iron rod set bearing N 15°-22'-38"E, a distance of 12.01 feet.

N 84°-04'-23"W, a distance of 144.01 feet to a point.

THENCE, with the south lines of the Jeffrey S. John 30 acre tract (O.R. 866, Pg. 262) and the Shane D. Boysel 68.56 acre tract (O.R. 456, Pg. 685, Tract II), N 75°-24'-31"E, a distance of 1369.16 feet to a point referenced by a 5/8 inch iron rod found bearing N 15°-41'-01"W, a distance of 0.61 feet, passing a 5/8 inch iron rod set at 14.00 feet.

THENCE, with the west line of the Orville L. Overmyer 7.041 acre tract (O.R. 109, Pg. 461), S 15°-41'-01"E, a distance of 656.02 feet to a 5/8 inch iron rod found on the south line of Virginia Military Survey 7318 and the north line of Virginia Military Survey 4676.

THENCE, with the south line of Virginia Military Survey 7318 and the north line of Virginia Military Survey 4676 and the south line of the said 7.041 acre tract,



# Lee Surveying and Mapping Co., Inc.

Land Surveys • Topography • Subdivisions • Construction Layout

117 N. Madriver St.  
Bellefontaine OH 43311

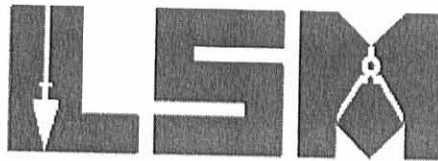

Phone: (937) 593-7335  
Fax: (937) 593-7444  
surveys@lsminc.us

N 73°-42'-53"E, a distance of 471.96 feet to a 5/8 inch iron rod found on the center-line of Township Road 147 at an angle point, passing a 5/8 inch iron rod set at 446.96 feet.

THENCE, with the south line of Virginia Military Survey 7318 and the north line of Virginia Military Survey 4676 and the center-line of Township Road 147, N 73°-42'-53"E, a distance of 370.30 feet to the point of beginning, passing a MAG nail found at 272.82 feet.

Containing 63.342 acres, of which 0.605 acre is within the highway right-of-way. There are 9.545 acres in Virginia Military Survey 7318, 22.735 acres in Virginia Military Survey 4676 and 31.062 acres in Virginia Military Survey 4497. There are 5.106 acres in Jefferson Township and 58.236 acres in Monroe Township.

The basis for bearings is the south line of Virginia Military Survey 7318, being N 73°-42'-53"E, and all other bearings are from angles and distances measured in a field survey by Lee Surveying and Mapping Co., Inc. on May 19, 2009.



ORIGINAL STAMP IN GREEN

Description prepared by:

*William K. Bruce*

William K. Bruce  
Professional Surveyor 7437  
May 22, 2009

4790059

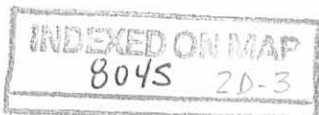

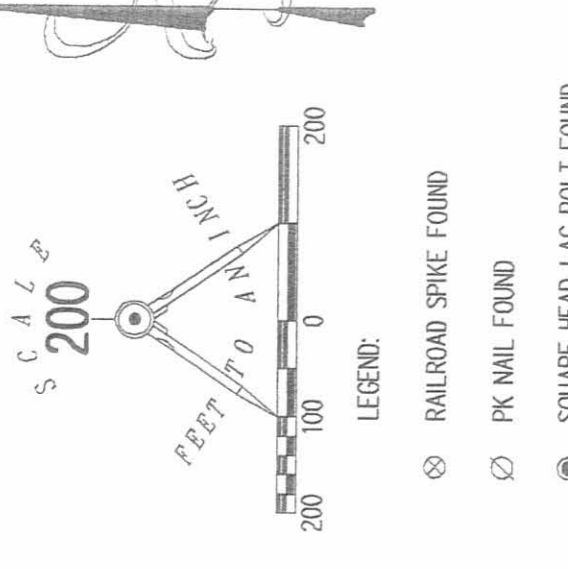

- LEGEND:
- ⊗ RAILROAD SPIKE FOUND
  - ⊙ PK NAIL FOUND
  - ⊕ SQUARE HEAD LAG BOLT FOUND
  - 5/8 INCH IRON ROD FOUND
  - 5/8 INCH IRON ROD SET
  - ⊙ 1 INCH IRON PIPE FOUND
  - ⊕ MAG NAIL FOUND

**ADJOINERS**

1. KIMBERLY K. REAMES  
1,136 ACRES  
O.R. 601, P.G. 660
2. BRIAN J. REAMES  
1,236 ACRES  
O.R. 660, P.G. 978
3. JERRY M. REAMES  
1,287 ACRES  
O.R. 63, P.G. 280

**CHORDS TO POINTS IN CENTER OF CREEK**

LINE	BEARING	DISTANCE
L1	N 49°59'53" W	77.50
L2	N 19°57'29" E	126.70
L3	N 76°56'16" W	86.76
L4	N 33°00'43" E	112.17
L5	N 58°23'46" E	78.04
L6	N 41°59'58" W	73.60
L7	N 82°25'24" W	65.48
L8	N 13°06'06" E	99.05
L9	N 76°58'40" W	57.79
L10	N 01°25'33" W	52.76
L11	N 25°15'32" W	67.74
L12	N 12°12'01" E	78.88
L13	N 31°02'12" E	55.62
L14	N 09°54'53" W	107.33
L15	N 55°00'42" E	97.86
L16	N 29°02'45" W	47.44
L17	N 20°10'07" E	33.75
L18	N 48°37'40" E	103.08
L19	N 54°43'27" W	13.77
L20	N 28°26'52" E	90.35
L21	S 88°17'10" E	100.30
L22	N 15°51'57" W	128.46
L23	N 20°18'18" E	99.33
L24	N 45°53'54" E	68.23
L25	N 43°09'10" W	68.36
L26	N 84°04'23" W	144.01

**BEARINGS AND DISTANCES FROM CENTER-LINE OF CREEK TO REFERENCE MONUMENT**

LINE	BEARING	DISTANCE
L27	N 86°49'18" E	44.87
L28	N 58°49'19" E	12.37
L29	N 80°45'12" E	24.65
L30	S 19°00'37" E	28.11
L31	S 72°27'29" E	8.14
L32	N 42°10'19" E	19.86
L33	N 52°54'21" E	13.80
L34	N 62°08'32" E	34.83
L35	N 83°18'32" E	14.57
L36	N 80°06'27" E	20.16
L37	S 50°23'48" E	14.92
L38	S 56°59'10" E	13.02
L39	S 58°42'14" E	9.46
L40	N 73°57'16" E	9.50
L41	S 80°03'56" E	12.26
L42	S 65°17'53" E	10.42
L43	S 78°59'55" E	4.60
L44	N 43°56'04" E	6.22
L45	S 22°07'46" E	16.89
L46	S 22°25'11" E	17.12
L47	S 81°21'35" E	28.89
L48	S 05°41'22" E	10.91
L49	S 30°24'37" E	7.66
L50	N 15°22'38" E	12.01

**CREEK DETAIL**  
NOT TO SCALE

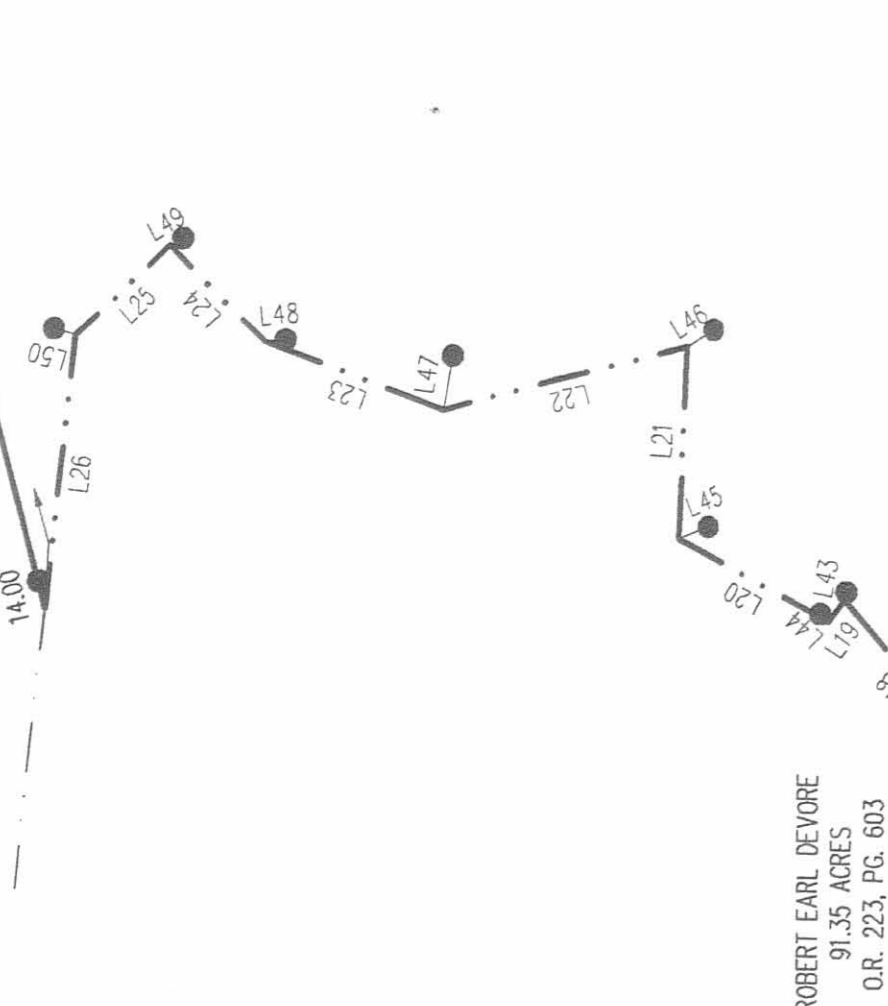

**SEE CREEK DETAIL**

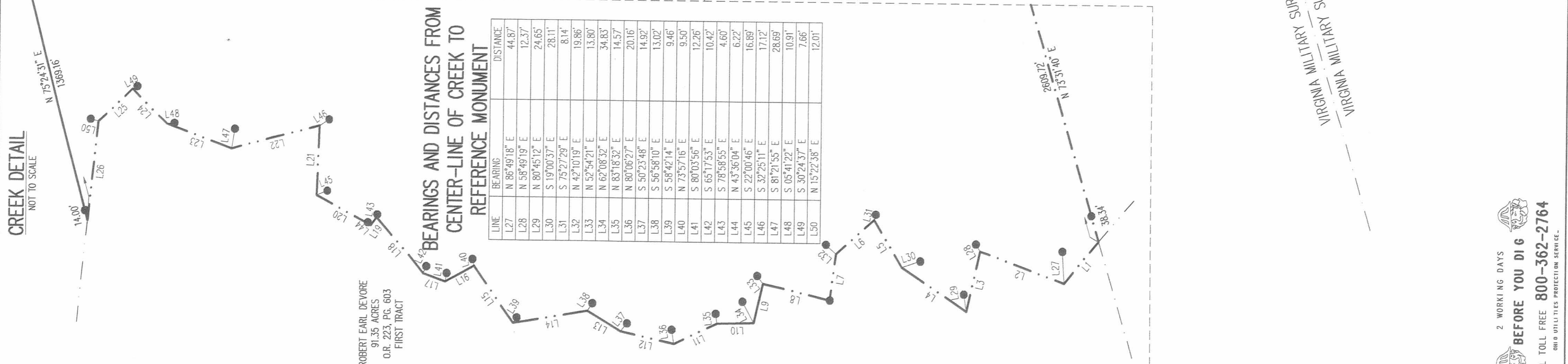
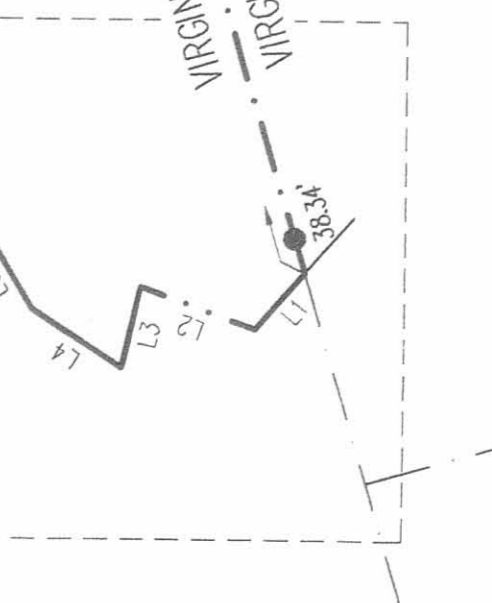

**SURVEY OF TWO TRACTS OUT OF THE JERRY M. REAMES AND DAVID B. REAMES 43.364 ACRE TRACT, 5.893 ACRE TRACT, 40 ACRE TRACT, 21.50 ACRE TRACT AND 28 ACRE TRACT OFFICIAL RECORD 650, PAGE 527 TRACT I, PARCEL 1 AND PARCEL 2, TRACT II, TRACT III AND TRACT IV VIRGINIA MILITARY SURVEYS 7318, 4676 AND 4497 JEFFERSON AND MONROE TOWNSHIP LOGAN COUNTY, OHIO**

SURVEYED BY:  
WILLIAM BRIDGES  
PROFESSIONAL SURVEYOR 7437  
MAY 19, 2009

COPYRIGHT 2009 BY:  
LEE SURVEYING & MAPPING CO., INC.  
BELLEVILLE, MO. 64601-4331  
(937) 593-7335  
SURVEYS@lism.com  
ISS 00509 479059 L-4790-1

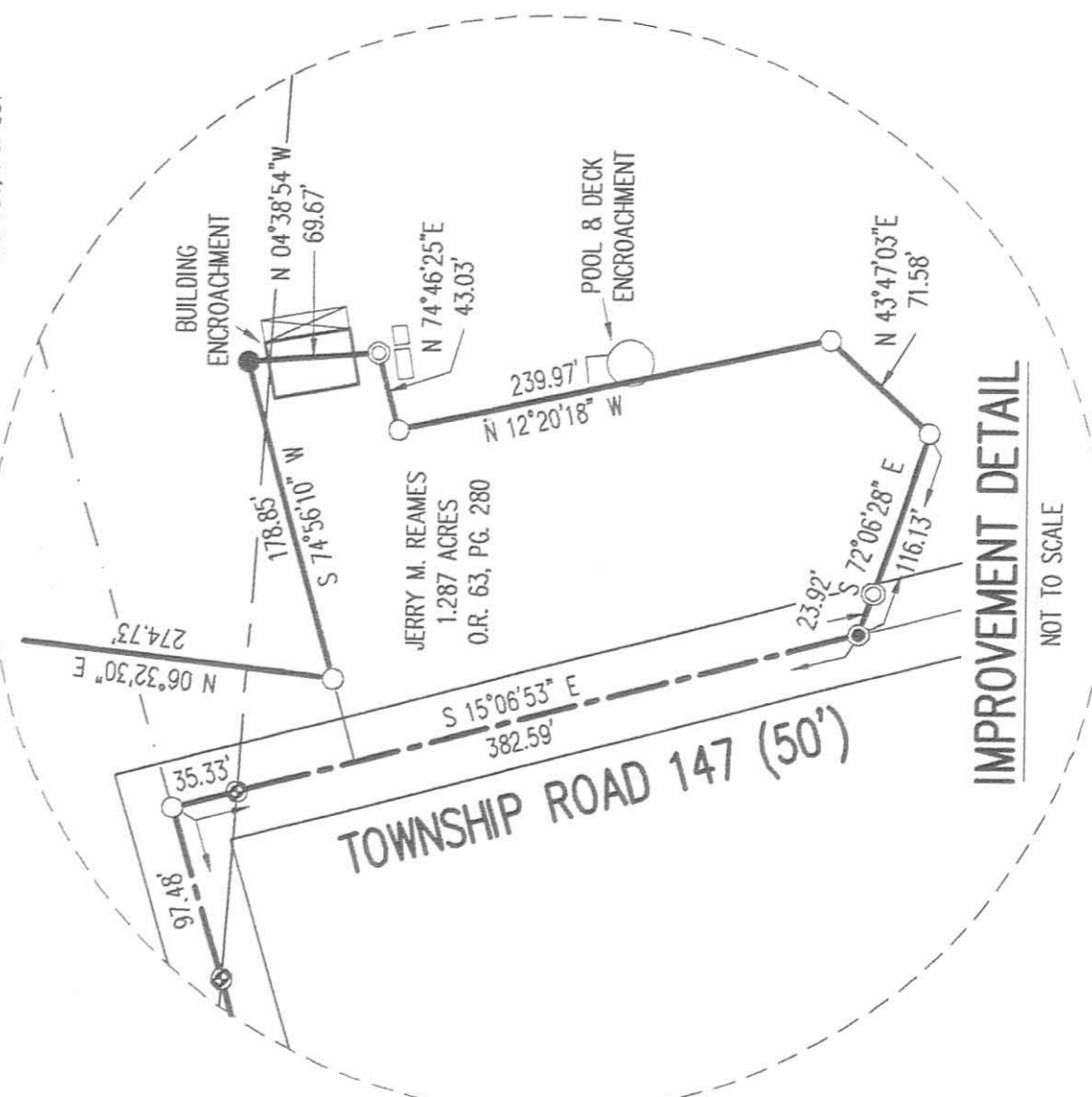
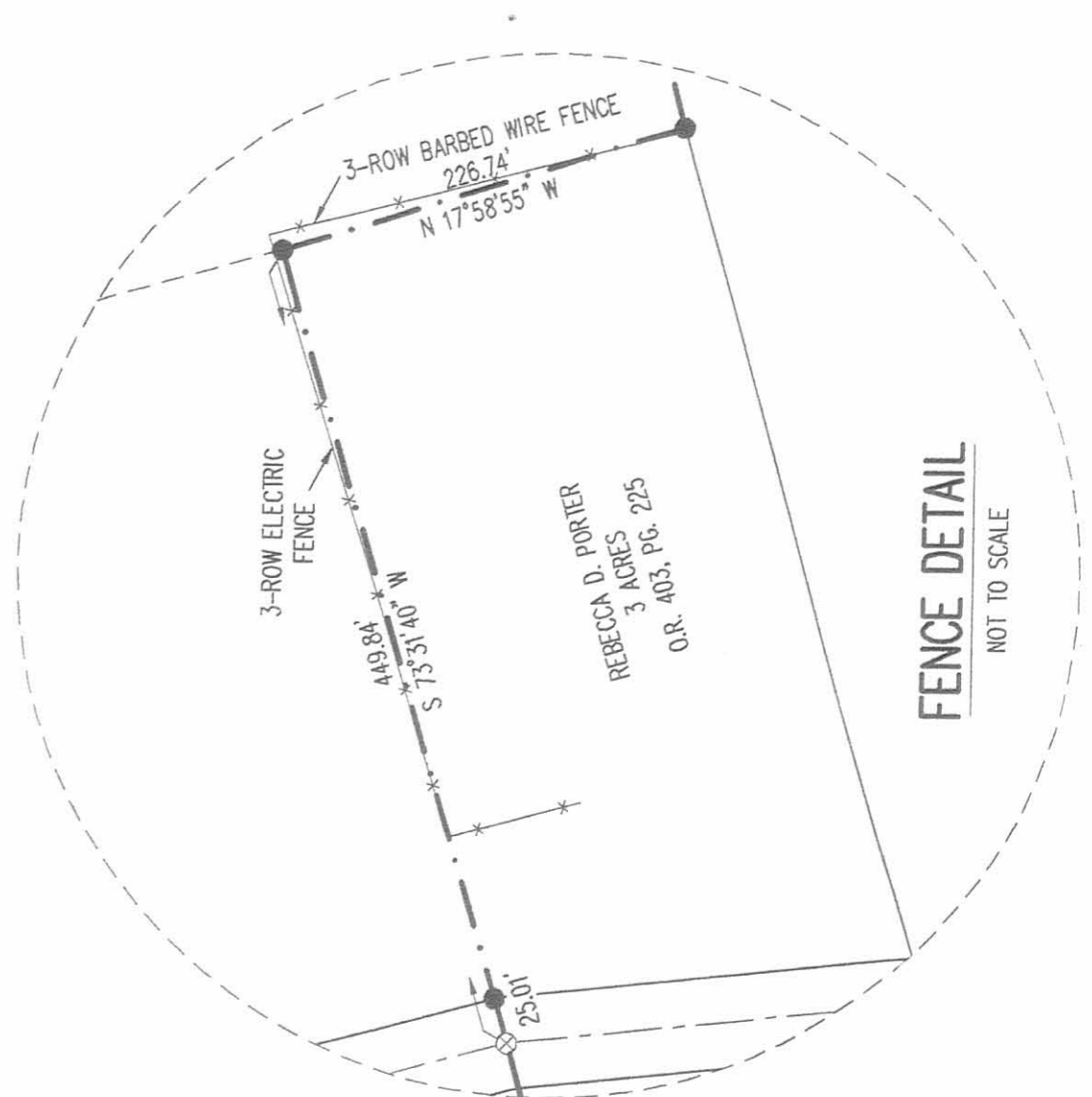

2 WORKING DAYS  
**BEFORE YOU DIG**  
CALL TOLL FREE 800-362-2764  
OR VISIT US ONLINE AT WWW.804S.COM

**804S**  
PUBLISHED ON MAP

9-5-13

# Lee Surveying and Mapping Co., Inc.



Land Surveys • Topography • Subdivisions • Construction Layout

117 N. Madriver St.  
Bellefontaine OH 43311



Phone: (937) 593-7335  
Fax: (937) 593-7444  
surveys@lsminc.us

## OVERMYER 2.196 ACRES

Lying in Virginia Military Survey 7318, Jefferson and Monroe Townships, Logan County, Ohio.

Being out of the Orville L. Overmyer and Patricia M. Overmyer 7.041 acre tract as deeded and described in Official Record 109, Page 461 of the Logan County Records of Deeds and being more particularly described as follows:

Beginning on a 5/8 inch iron rod found on the south line of Virginia Military Survey 7318 and the center-line of Township Road 147 at an angle point.

THENCE, with the south line of Virginia Military Survey 7318 and a northerly line of the David B. Reames 63.342 acre tract (O.R. 978, Pg. 807), S 73°-42'-48"W, a distance of 471.96 feet to a 5/8 inch iron rod found, passing a 5/8 inch iron rod found at 25.00 feet.

THENCE, with an east line of the said 63.342 acre tract, N 15°-41'-01"W, a distance of 202.73 feet to a 5/8 inch iron rod set.

THENCE, N 73°-42'-53"E, a distance of 471.79 feet to a MAG nail set on the center-line of Township Road 147, passing a 5/8 inch iron rod set at 446.79 feet.

THENCE, with the center-line of Township Road 147 (50 feet wide), S 15°-43'-47"E, a distance of 202.72 feet to the point of beginning.

Containing 2.196 acres, of which 0.116 acre is within the highway right-of-way. There is 0.335 acre within Jefferson Township and 1.861 acres within Monroe Township.

Property is subject to any and all previous easements and rights-of-way of record.

The basis for bearings is the south line of Virginia Military Survey 7318, being S 73°-42'-48"W, and all other bearings are from angles and distances measured in a field survey by Lee Surveying and Mapping Co., Inc. on August 29, 2013.



ORIGINAL STAMP IN GREEN

Description prepared by:

William K. Bruce  
Professional Surveyor 7437  
August 30, 2013

47900813



9-5-13

**APPROVED**

LEGEND:

- MAG NAIL SET
- 5/8 INCH IRON ROD FOUND
- 5/8 INCH IRON ROD SET WITH PLASTIC I.D. CAP STAMPED "LSM 7437"

ORVILLE L. OVERMYER AND  
PATRICIA M. OVERMYER  
7.041 ACRES  
O.R. 109, PG. 461

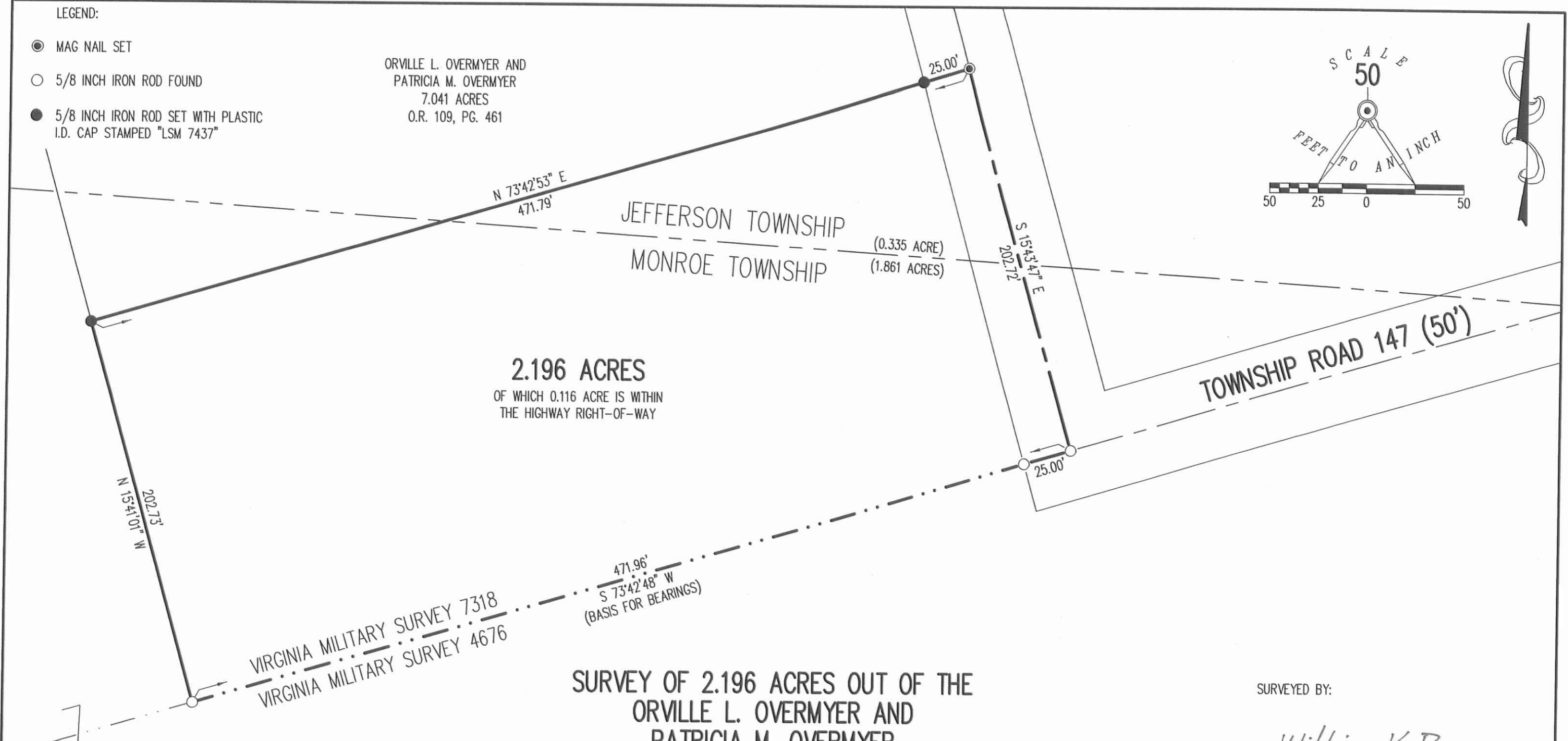
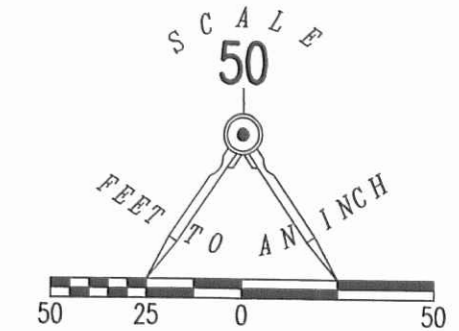

**2.196 ACRES**  
OF WHICH 0.116 ACRE IS WITHIN  
THE HIGHWAY RIGHT-OF-WAY

**SURVEY OF 2.196 ACRES OUT OF THE  
ORVILLE L. OVERMYER AND  
PATRICIA M. OVERMYER  
7.041 ACRE TRACT  
OFFICIAL RECORD 109, PAGE 461  
VIRGINIA MILITARY SURVEY 7318  
JEFFERSON AND MONROE TOWNSHIPS  
LOGAN COUNTY, OHIO**

DAVID B. REAMES  
63.342 ACRES  
O.R. 978, PG. 807

SURVEYED BY:

*William K. Bruce*  
WILLIAM K. BRUCE  
PROFESSIONAL SURVEYOR 7437  
AUGUST 29, 2013

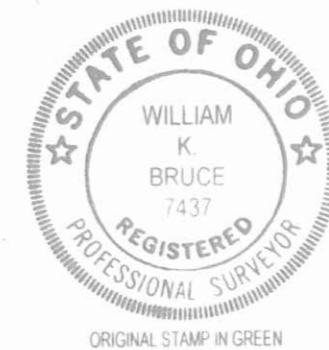

ORIGINAL STAMP IN GREEN

COPYRIGHT 2013 BY:  
**LEE SURVEYING & MAPPING CO., INC.**  
117 North Madriver Street  
BELLEFONTAINE, OHIO 43311  
(937) 593-7335  
WWW.LSMINC.US  
surveys@lsminc.us  
KSS D0813 47900813 L-4790-3

2 WORKING DAYS  
**BEFORE YOU DIG**  
CALL TOLL FREE **800-362-2764**  
OHIO UTILITIES PROTECTION SERVICE.

INDEXED ON MAP  
8045 3P