

Deed Description
Adda C. Line Survey

Situated in the Township of Liberty, in the County of Logan, in the State of Ohio and being in Section 28, Town 5, Range 13; Beginning at the intersection of the centerlines of Logan County Highway # 14 (Degraff Pike) with the centerline of Logan County Highway # 189 (former U.S. Route # 68), thence with the centerline of said Logan County Highway # 189 North 12 Degrees 53 Minutes West 623.06 feet to a spike which is the true point of beginning of this description.

Thence continuing with the centerline of said Logan County Highway #189 North 12 Degrees 53 Minutes West 282.00 feet to an iron pin; Thence South 79 Degrees 35 Minutes West 240.10 feet to an iron pin; Thence South 00 Degrees 25 Minutes West 250.35 feet to an iron pin; Thence North 86 Degrees 25 Minutes East 301.45 feet to the point of beginning, containing 1.64 acres more or less out of Adda C. Line's 23.75 acres as described in Volume 203, Page 100 of the Logan County Recorder's Deed Records.

Surveyed April 30, 1976
By Larry E. Blosser SIT # 1199

Checked By: Daniel E. Gilbert, P.S.
Reg. Surveyor # 5402

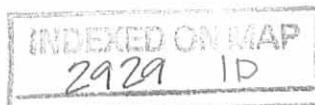

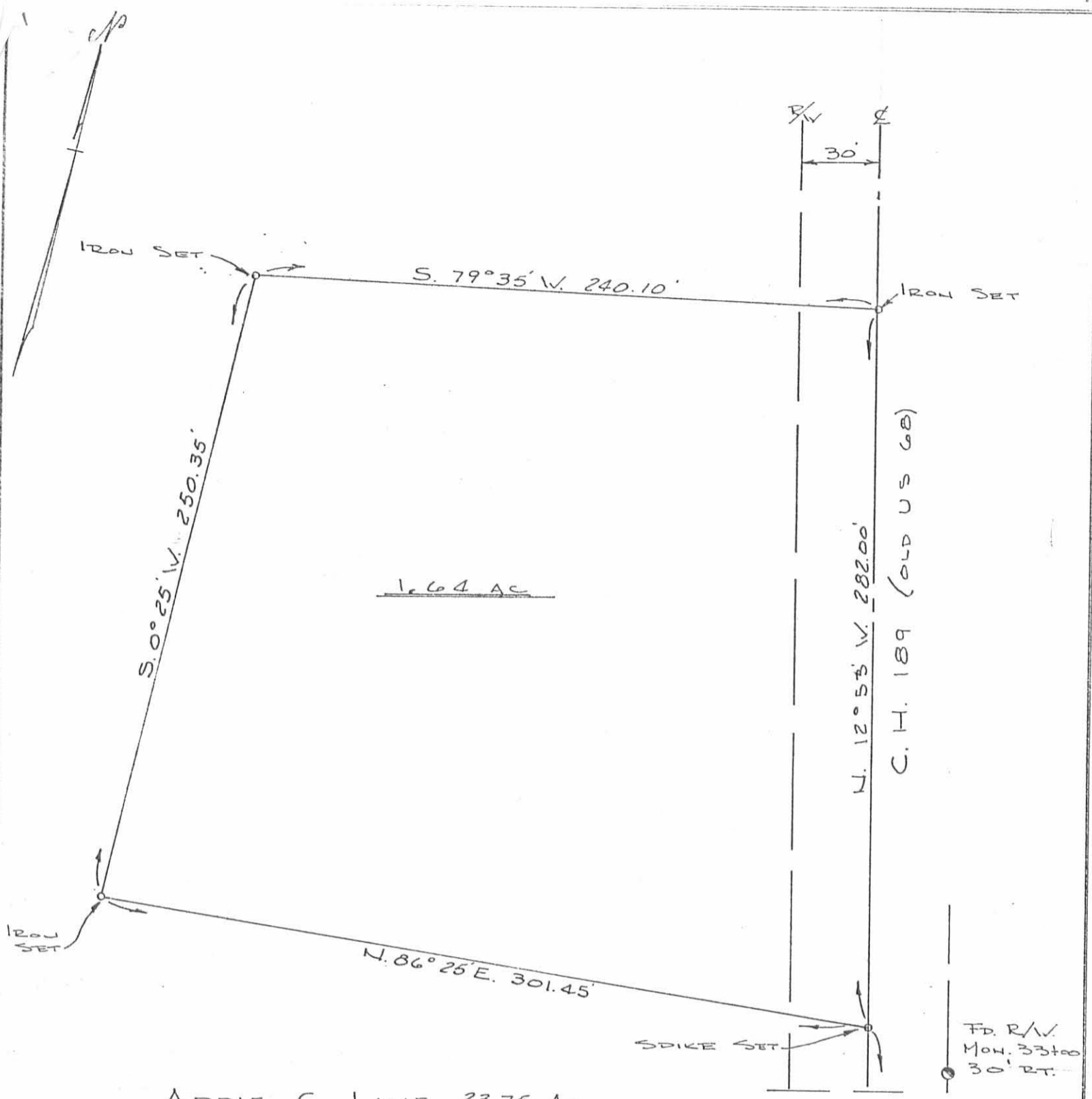

ADDIE C. LINE 23.75 AC.

2929 IP

INDEXED ON MAP

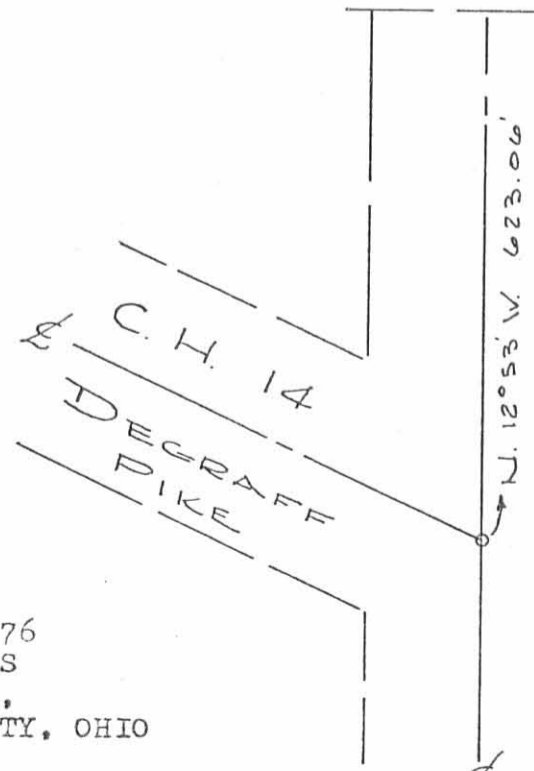

ADDA C. LINE SURVEY APRIL 1976
 1.64 ACRES OUT OF 23.75 ACRES
 SECTION 28, TOWN 5, RANGE 13,
 LIBERTY TOWNSHIP, LOGAN COUNTY, OHIO

BY: Larry E. Blosser SIT # 1199

CK. DANIEL E. GILBERT, P.S. REC SUR No 5702

March 17, 1992

Being part of a 1.64 acre tract (Vol. 375, Pg. 19 & 20) in the Southwest Quarter of Section 28, Town 5, Range 13, B.T.M.R.S., Liberty Township, Logan County, Ohio and more particularly described as follows:

Beginning for reference, at a railroad spike set replacing a P. K. nail found marking the intersection of the centerlines of CH 189 and CH 14; thence North 12 degrees 53 minutes 00 seconds West (Ref Brg Vol. 375, Pg. 19 & 20) 837.50 feet to a 5/8 x 30 inch capped iron pin set in the East line of said 1.64 acre tract and the old centerline of said CH 189 at the principal place of beginning for the tract hereinafter described; thence North 58 degrees 59 minutes 23 seconds West 101.68 feet to a 5/8 x 30 inch capped iron pin set in the North line of said 1.64 acre tract; thence North 79 degrees 29 minutes 30 seconds East 73.33 feet to a 5/8 inch iron pin found marking the Northeast corner of said 1.64 acre tract; thence South 12 degrees 53 minutes 00 seconds East 67.46 feet to the principal place of beginning. Containing 0.056 acres more or less and subject to all legal highways and easements of record or use. 0.036 acres being in road right of way.

Survey, description and plat by Wallace Lynn Geuy
Wallace Lynn Geuy
Registered Surveyor No. S-5105
8673 W. Rt. 29
DeGraff, OH 43318

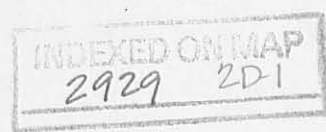

Hastetter to Mitchell

March 17, 1992

Being part of a 7.65 acre tract (Vol. 379, Pg. 123) in the Southwest Quarter of Section 28, Town 5, Range 13, B.T.M.R.S., Liberty Township, Logan County, Ohio and more particularly described as follows:

Beginning for reference, at a railroad spike set replacing a P. K. nail found marking the intersection of the centerlines of CH 189 and CH 14; thence North 12 degrees 53 minutes 00 seconds West (Ref Brg Vol. 375, Pg. 19 & 20) 837.50 feet to a 5/8 x 30 inch capped iron pin set in the East line of a 1.64 acre tract (Vol. 375 Pg. 19 & 20) and the old centerline of said CH 189; thence North 58 degrees 59 minutes 23 seconds West 101.68 feet to a 5/8 x 30 inch capped iron pin set in the North line of said 1.64 acre tract at the principal place of beginning for the tract hereinafter described; thence South 79 degrees 29 minutes 30 seconds West 167.05 feet to a 5/8 inch iron pin found marking the Northwest corner of said 1.64 acre tract; thence North 0 degrees 27 minutes 40 seconds East 47.55 feet to a capped 5/8 inch iron pin found; thence South 89 degrees 04 minutes 32 seconds East 139.20 feet to a capped iron pin set; thence South 58 degrees 59 minutes 23 seconds East 28.80 feet to the principal place of beginning. Containing 0.112 acres more or less and subject to all easements of record or use.

Survey, description and plat by

Wallace Lynn Geuy

Wallace Lynn Geuy
Registered Surveyor No. S-5105
8673 W. Rt. 29
DeGraff, OH 43318

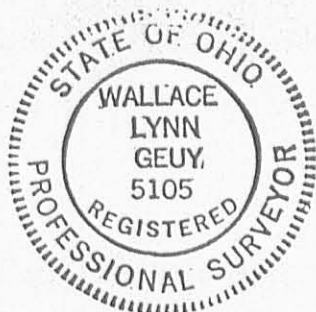

INDEXED ON MAP

2929 2DZ

Ref.
 Survey 2929
 Survey
 DB Vol 379 Pg 19 & 20
 DB Vol 405 Pg 284
 DB Vol 379 - Pg 122

INDEXED ON MAP
 2929 ZP

DP&L Co.
 50' R/W
 Vol 276 Pg 15
 8-14-61

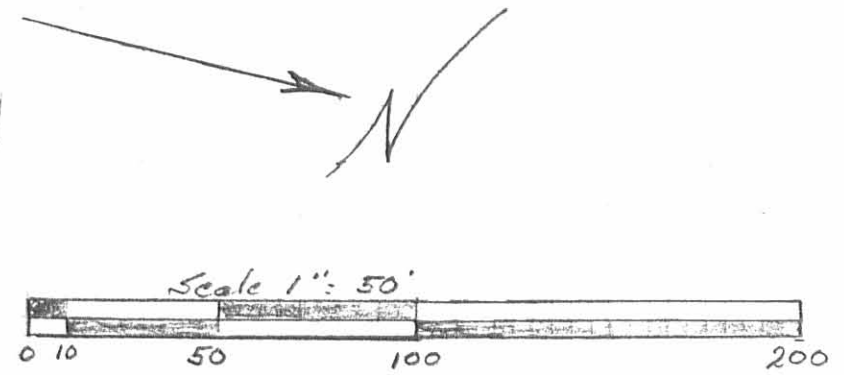

William L. Hostetter Parcel
 7.65 Acre
 Vol 379 Pg 123
 19-135-00-00-120

Charles William Mitchell
 & Betty Louise Mitchell
 1.67 Acre
 Vol 375 Pg 19 & 20
 Parcel 19-135-00-00-119

Cone R/W mon
 Pnd.

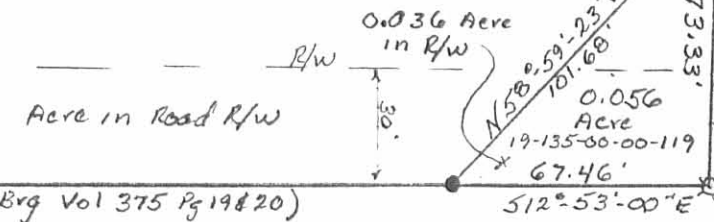
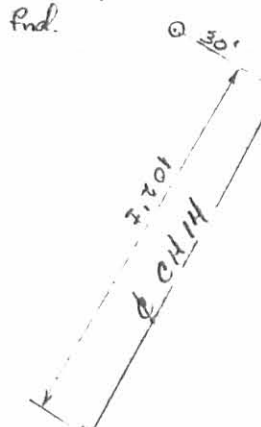

837.50
 N 12°-53'-00" W (Ref Brg Vol 375 Pg 19 & 20)

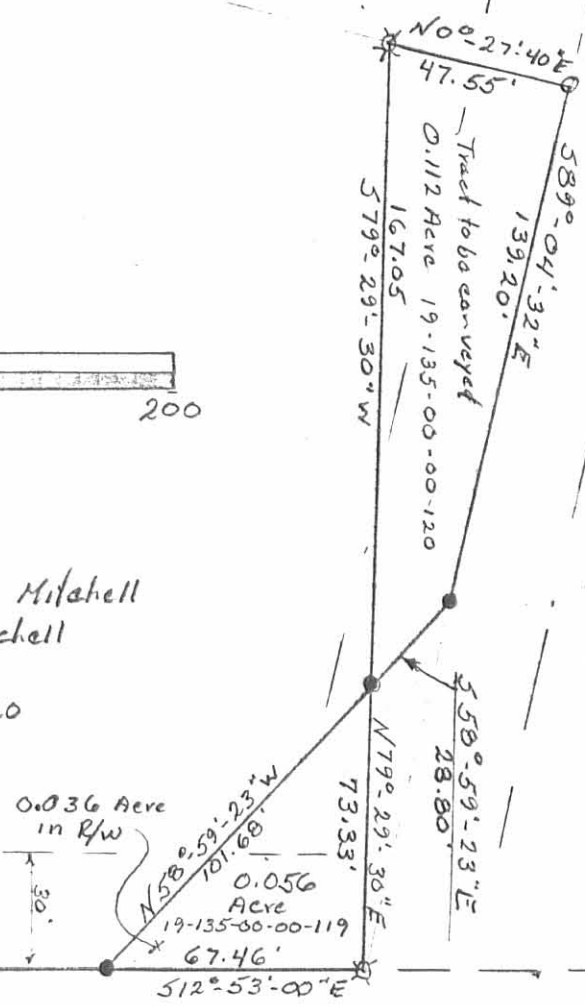

Surveyed by Wallace Lynn Geuy
 Registered Surveyor No. 5105
 17 March 92
 ■ Railroad spike set.
 ● 5/8 inch capped iron pin found
 ● 5/8 x 30 inch capped iron pin set
 ☆ 5/8 inch iron pin found



William Hostetter - Charles Mitchell
 Survey Plat.
 Being part of the SW 1/4 of Section 28,
 Town 5, Range 13, B.T.M.R.S., Liberty Twp.,
 Logan County, Ohio.
 Drawn by: WALLACE LYNN GEUY
 8673 West Rt. 29
 DEGRAFF Ohio 43318
 362-2755

LESLIE H. GEESLIN
REGISTERED SURVEYOR 5248
P. O. BOX 274
RUSHSVLVANIA, OHIO 43347
TELEPHONE: (937) 468-2793
FAX: (937) 468-2080

McCOY - PIATT SURVEY

April 28, 1999

The following described real estate situated in the State of Ohio, County of Logan, Township of Liberty, being part of Section 34, Town 5, Range 13 and more particularly described as follows:

Beginning at a 1/2 inch iron bar found in the centerline of County Highway 14 at the southwest corner of The Kroger Company's 13.815 acre tract as described in D. B. Vol. 405 Page 284.

Thence with said centerline N. 45° 42' 52" W. 364.75 feet to a 5/8 inch iron bar found at an angle in said C. H. 14.

Thence with said centerline N. 40° 01' 01" W. 218.45 feet to a magnetic nail set.

Thence N. 50° 41' 09" E. 272.09 feet to a 5/8 inch iron bar set in the west line of William L. Hostetler etal's original 28.30 acre tract as described in D. B. Vol. 379 Page 123, passing a 5/8 inch iron bar set at 30.00 feet.

Thence with the west line of said Hostetler and The Kroger Company S. 17° 49' 14" E. 624.33 feet to the place of beginning, passing a 5/8 inch iron bar found at 560.20 feet.

Containing 1.905 acres more or less, of which 0.382 acre is in the right of way of C. H. 14.

The above described 1.905 acre tract being on the south side of Phyllis E. Piatt's 5.23 acre tract as described in D. B. Vol. 404 Page 210.

Bearings are based on an assumed bearing (N. 45° 42' 52" W.) for the centerline of C. H. 14 in this field survey by Leslie H. Geeslin, Reg. Surveyor No. 5248, on April 28, 1999.



Leslie H. Geeslin

INDEXED
29 293D-1

REC'D 5-3-99 SWM BK ✓

LESLIE H. GEESLIN

REGISTERED SURVEYOR 5248

P. O. BOX 274

RUSHSVLVANIA, OHIO 43347

TELEPHONE: (937) 468-2793

FAX: (937) 468-2080

McCOY - PIATT SURVEY

April 28, 1999

The following described real estate situated in the State of Ohio, County of Logan, Township of Liberty, being part of Section 34, Town 5, Range 13 and more particularly described as follows:

Beginning at a 3/4 inch iron pipe found in the centerline of County Highway 14 at the southwest corner of Woodland Rest Allotment as shown in Cabinet "A" Slide 345 of the Logan County Records Office.

Thence with the south line of said Woodland Rest Allotment N. 80° 31' 29" E. 457.84 feet to a 3/4 inch iron pipe found at the northwest corner of William L. Hostetler etal's original 28.30 acre tract as described in D. B. Vol. 379 Page 123 , passing a 5/8 inch iron barfound at 34.83 feet.

Thence with said Hostetler's west line S. 17° 49' 14" E. 323.58 feet to a 5/8 inch iron bar set.

Thence S. 50° 41' 09" W. 272.09 feet to a magnetic nail set in the centerline of said C. H. 14, passing a 5/8 inch iron bar set at 242.09 feet.

Thence with said centerline N. 40° 01' 01" W. 528.92 feet to the place of beginning.

Containing 3.334 acres more or less, of which 0.358 acre is in the right of way of C. H. 14.

The above described 3.334 acre tract being on the north side of Phyllis E. Piatt's 5.23 acre tract as described in D. B. Vol. 404 Page 210.

Bearings are based on an assumed bearing (N. 40° 01' 01" W.) for the centerline of C. H. 14 in this field survey by Leslie H. Geeslin, Reg. Surveyor No. 5248 on April 28, 1999.



29293D2

Leslie H. Geeslin

WOODLAND REST ALLOTMENT
CABINET A SLIDE 345

Leslie H. Geeslin
LESLIE H. GEESLIN
PENNSYLVANIA, OHIO
PH 937-468-2793



2929 BP

- LEGEND:
- ⊙ = 3/4" IRON PIPE FOUND
 - = 5/8" IRON BAR FOUND
 - = MAGNETIC NAIL SET
 - ◐ = 1/2" IRON BAR FOUND
 - = 5/8" IRON BAR SET

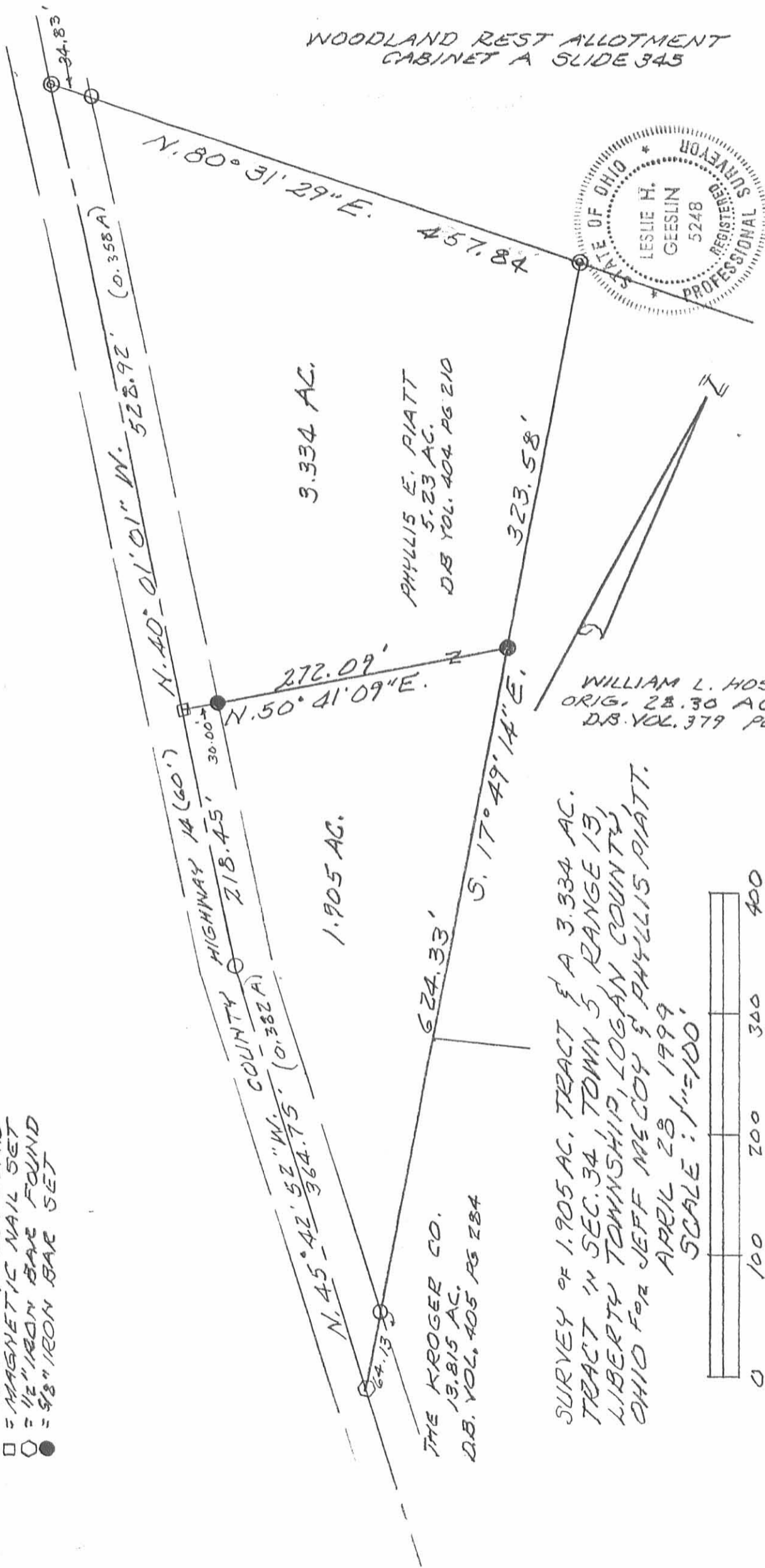

Rec'd 5-3-99 Survey

May 12, 1992

Being part of a 7.65 acre tract (Vol. 379 Pg.123) in the SW 1/4 of Section 28 and part of a 5.195 acre tract (Vol. 379 Pg. 123) in the SE 1/4 of Section 34, Town 5, Range 13, B.T.M.R.S., Liberty Township, Logan County, Ohio and more particularly described as follows:

Beginning, for reference, at a railroad spike set replacing a P.K. nail found marking the intersection of the centerlines of C.H. 14 and C.H. 189 (old USR 68); thence North 12 degrees 53 minutes 00 seconds West (Ref. Brg. Vol. 379 Pg. 19 & 20) 904.96 feet to a 5/8 inch iron pin found marking the Southeast corner of William Hostetler's 7.65 acre tract (Vol. 379 Pg. 123) and the principal place of beginning for the tract hereinafter described; thence South 79 degrees 29 minutes 30 seconds West 73.33 feet to a 5/8 x 30 inch capped iron pin set; thence North 58 degrees 59 minutes 23 seconds West 28.80 feet to a 5/8 x 30 inch iron pin set; thence North 89 degrees 04 minutes 32 seconds West 139.20 feet to a 5/8 inch capped iron pin found; thence North 87 degrees 11 minutes 43 seconds West 318.14 feet to a 5/8 x 30 inch iron pin set; thence North 3 degrees 40 minutes 07 seconds West 339.36 feet to a 5/8 x 30 inch iron pin set; thence North 85 degrees 33 minutes 25 seconds East 486.42 feet to a railroad spike set in the West berm of USR 68 and in old USR 68 centerline, passing a 5/8 x 30 inch iron pin set at 427.82 feet in the Westerly R/W line of said USR 68; thence South 12 degrees 53 minutes 00 seconds East 405.84 feet to the principal place of beginning. Containing 4.434 acres more or less and subject to all legal highways and easements of record or use.

4.238 acres being in Section 28 and 0.196 acres being in Section 34.
0.375 acres being in USR 68 right of way.

Survey, description and plat by Wallace Lynn Geuy
Wallace Lynn Geuy
Registered Surveyor No. S-5105
8673 W. Rt. 29
DeGraff, OH 43318



INDEXED ON MAP
2929 40

William L. Hostetter 5.195 Acres
 Vol 379 Pg 123
 Parcel 19-135-00-00-121

Ref
 Survey 2929
 D.B. Vol 379 Pg 123
 D.B. Vol 405 Pg 284
 D.B. Vol 379 Pg 123
 D.B. Vol 375 Pg 19 & 20



Total Tract to be conveyed 4.434 Acres
 Parcel 19-135-00-00-120 4.238 Acre.
 Parcel 19-135-00-00-121 0.196 Acre.

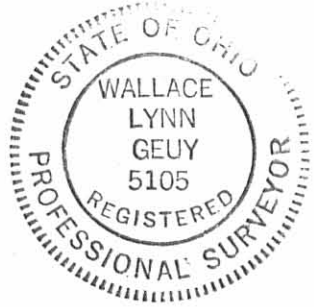

Surveyed by Wallace Lynn Geuy
 Registered Surveyor No. 5105
 12 May 92

- Railroad spike set.
- 5/8 inch capped iron pin found.
- 5/8 x 30 inch capped iron pin set.
- ⊗ 5/8 inch iron pin found.
- ⊙ 6" diameter cone. R/W mon. found..

CH 114 R/W
 N 12° 53' 00" W 904.96'
 CH 189 (Old USR 68)
 N 87° 11' 43" W 318.44'
 N 89° 04' 32" W 139.20'
 N 58° 59' 23" W 281.80'
 79.33'
 579° 29' 30" W
 405.80
 S 12° 53' 00" E (Ref Brg. Vol 375 Pg 19 & 20)
 R/W line.
 0.275 Acre in R/W
 Old USR 68

Lee Surveying and Mapping Co., Inc.

Land Surveys • Topography • Subdivisions • Construction Layout

117 N. Madriver St.
Bellefontaine OH 43311

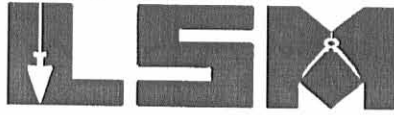

Phone: (937) 593-7335
Fax: (937) 593-7444

HOSTETLER 3.076 ACRES

Lying in Sections 28 and 34, Township 5, Range 13, Village of West Liberty, Liberty Township, Logan County, Ohio.

Being out of the William L. Hostetler, Gladys E. Hostetler, J. David Hostetler and Shirley Ann Hostetler original 26.66 acre tract as deeded and described in Volume 379, Page 123 of the Logan County Records of Deeds and being more particularly described as follows:

Beginning at a railroad spike found at the intersection of the center-lines of County Highway 189 and County Highway 14.

THENCE, with the center-line of County Highway 189 and U.S. Route 68 (varied width), N 12°-30'-00" W, a distance of 1310.83 feet to a point at the TRUE POINT OF BEGINNING.

THENCE, with the north line of the William L. Hostetler 4.434 acre tract (O.R. 165, Pg. 121), S 85°-59'-10" W, a distance of 485.52 feet to a 5/8 inch iron rod found, passing a 5/8 inch iron rod found at 57.58 feet.

THENCE, N 3°-13'-09" W, a distance of 315.57 feet to a 5/8 inch iron rod set.

THENCE, with the south line of the Landex original 19.92 acre tract (O.R. 176, Pg. 902), S 87°-25'-30" E, a distance of 444.62 feet to a MAG nail set, passing a concrete right-of-way monument found at 381.69 feet.

THENCE, with the center-line of U.S. Route 68 and County Highway 189, S 12°-30'-00" E, a distance of 267.45 feet to the point of beginning.

Containing 3.076 acres, of which 0.405 acre is within the highway right-of-way, 0.523 acre is in Section 34 and 2.553 acres are in Section 28.

The basis for bearings is the center-line of County Highway 189, being N 12°-30'-00" W, and all other bearings are from angles and distances measured in a field survey by Lee Surveying and Mapping Co., Inc. on December 7, 2001.

Description prepared by:



ORIGINAL STAMP IN GREEN

Jeffrey I. Lee
Professional Surveyor 6359
January 9, 2002

L-3278

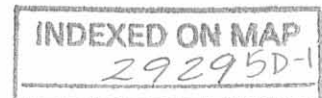

Lee Surveying and Mapping Co., Inc.

Land Surveys • Topography • Subdivisions • Construction Layout

117 N. Madriver St.
Bellefontaine OH 43311



Phone: (937) 593-7335
Fax: (937) 593-7444

HOSTETLER 3.657 ACRES

Lying in Sections 28 and 34, Township 5, Range 13, Village of West Liberty, Liberty Township, Logan County, Ohio.

Being out of the William L. Hostetler, Gladys E. Hostetler 4.434 acre tract as deeded and described in Official Record 165, Page 121 of the Logan County Records of Deeds and being more particularly described as follows:

Beginning at a railroad spike found at the intersection of the center-lines of County Highway 189 and County Highway 14.

THENCE, with the center-line of County Highway 189 and U.S. Route 68 (varied width), N 12°-30'-00" W, a distance of 966.85 feet to a 5/8 inch iron rod set at the TRUE POINT OF BEGINNING.

THENCE, N 88°-44'-08" W, a distance of 219.82 feet to a 5/8 inch iron rod set, passing a 5/8 inch iron rod set at 30.89 feet.

THENCE, N 86°-44'-29" W, a distance of 323.87 feet to a 5/8 inch iron rod set.

THENCE, with the lines of the William L. Hostetler original 26.66 acre tract (Vol. 379, Pg. 123), the following two (2) courses:

N 3°-13'-09" W, a distance of 279.02 feet to a 5/8 inch iron rod found;

N 85°-59'-10" E, a distance of 485.52 feet to a point, passing a 5/8 inch iron rod found at 427.94 feet.

THENCE, with the center-line of U.S. Route 68 and County Highway 189, S 12°-30'-00" E, a distance of 343.98 feet to the point of beginning.

Containing 3.657 acres, of which 0.325 acre is within the highway right-of-way, 0.192 acre is in Section 34 and 3.465 acres are in Section 28.

The basis for bearings is the center-line of County Highway 189, being N 12°-30'-00" W, and all other bearings are from angles and distances measured in a field survey by Lee Surveying and Mapping Co., Inc. on December 7, 2001.

Description prepared by:



ORIGINAL STAMP IN GREEN

Jeffrey I. Lee
Jeffrey I. Lee
Professional Surveyor 6359
January 9, 2002

L-3278

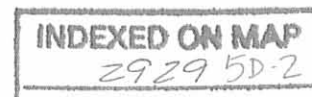

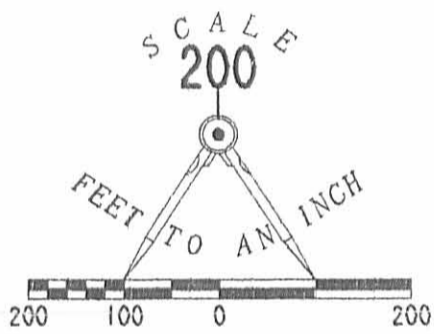
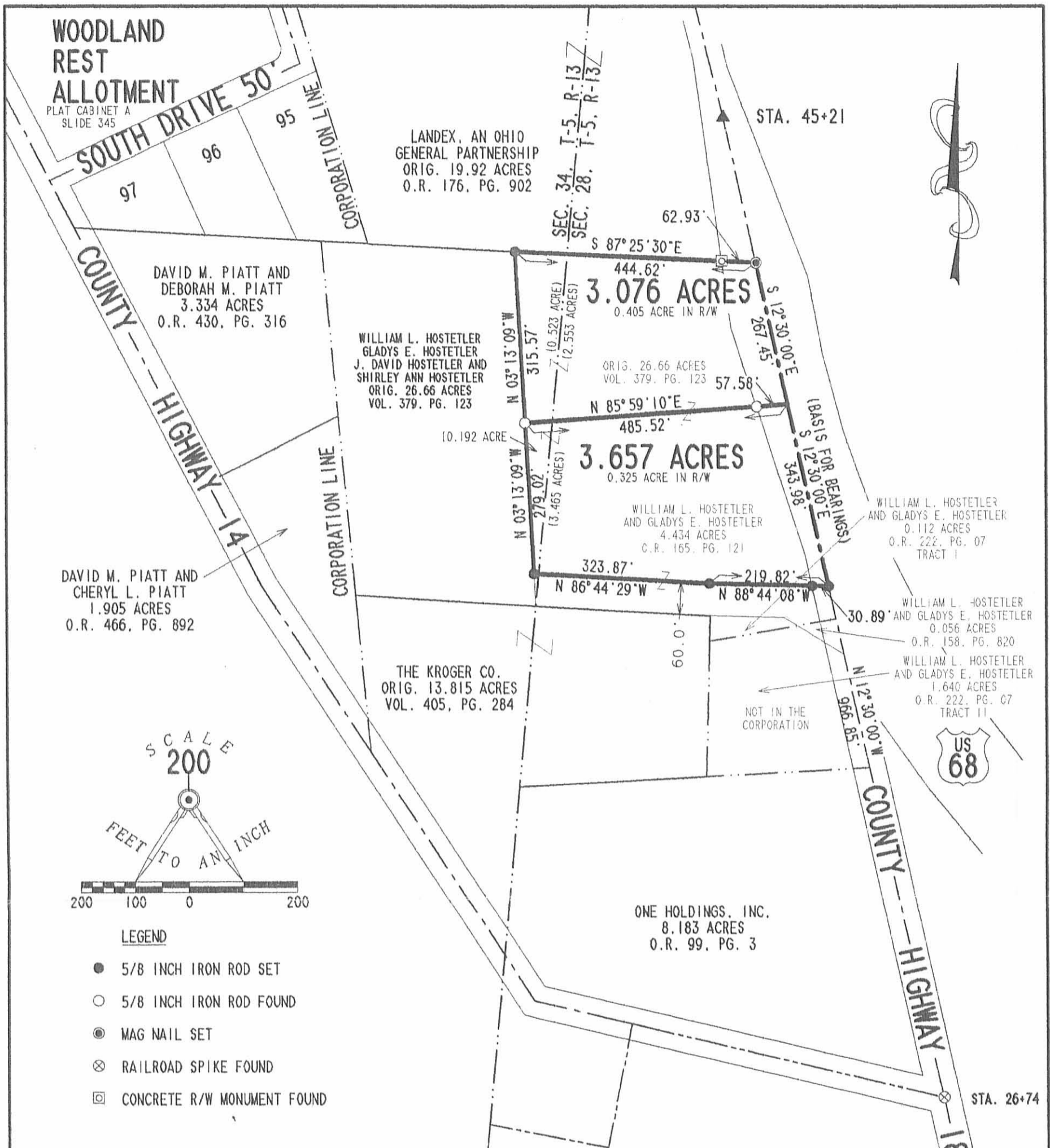

- LEGEND**
- 5/8 INCH IRON ROD SET
 - 5/8 INCH IRON ROD FOUND
 - ⊙ MAG NAIL SET
 - ⊗ RAILROAD SPIKE FOUND
 - ⊠ CONCRETE R/W MONUMENT FOUND

SURVEY OF 3.076 ACRES OUT OF
THE WILLIAM L. HOSTETLER, GLADYS E. HOSTETLER,
J. DAVID HOSTETLER AND SHIRLEY ANN HOSTETLER
ORIGINAL 26.66 ACRES TRACT
VOLUME 379, PAGE 123 AND
AND SURVEY OF 3.657 ACRE OUT OF THE
WILLIAM L. HOSTETLER AND GLADYS E. HOSTETLER
4.434 ACRE TRACT
OFFICIAL RECORD 165, PAGE 121
SECTION 28 AND 34, TOWN 5, RANGE 13
VILLAGE OF WEST LIBERTY
LIBERTY TOWNSHIP
LOGAN COUNTY, OHIO

INDEXED ON MAP
2929 5P



SURVEYED BY:

 JEFFREY I. LEE
 PROFESSIONAL SURVEYOR 6359
 DECEMBER 7, 2001

COPYRIGHT 2001 BY:
LEE SURVEYING & MAPPING CO., INC.
 117 North Madriver Street
 BELLEFONTAINE, OHIO 43311
 (937) 593-7335

2 WORKING DAYS
BEFORE YOU DIG
 CALL TOLL FREE **800-362-2764**
 OHIO UTILITIES PROTECTION SERVICE.

ORIGINAL STAMP IN GREEN

Lee Surveying and Mapping Co., Inc.

Land Surveys • Topography • Subdivisions • Construction Layout

117 N. Madriver St.
Bellefontaine OH 43311

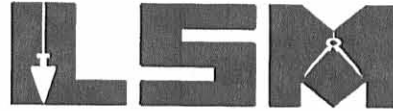

Phone: (937) 593-7335
Fax: (937) 593-7444

HOSTETLER 30 FEET WIDE INGRESS/EGRESS EASEMENT

Lying in Section 28, Township 5, Range 13, Village of West Liberty, Liberty Township, Logan County, Ohio.

Being a 30 feet wide ingress/egress easement for the purpose of access to the existing lumber company's buildings over the William L. Hostetler and Gladys E. Hostetler original 4.434 acre tract as deeded and described in Official Record 165, Page 121 of the Logan County Records of Deeds and being more particularly described as follows:

Beginning at a point on the center-line of County Highway 189 on the southeast corner of the said original 4.434 acre tract.

THENCE, with the south line of the said original 4.434 acre tract and the north line of the William L. Hostetler 0.056 acre tract (O.R. 158, Pg. 820), S 79°-54'-49" W, a distance of 50.00 feet to a point on the center-line of the easement at the TRUE POINT OF BEGINNING.

THENCE, with the center-line of the easement, N 54°-00'-00" W, a distance of 122.40 feet to a point on the south line of a proposed 3.629 acre tract at the terminus of the easement referenced by a 5/8 inch iron rod set S 88°-44'-08" E, a distance of 135.00 feet and on the southeast corner of the said 3.629 acre tract.

The basis for bearings is the center-line of County Highway 189, being N 12°-30'-00" W, and all other bearings are from angles and distances measured in a field survey by Lee Surveying and Mapping Co., Inc. on December 7, 2001.

Description prepared by:



ORIGINAL STAMP IN GREEN

[Handwritten Signature]
Jeffrey I. Lee
Professional Surveyor 6359
January 9, 2002

L-3278

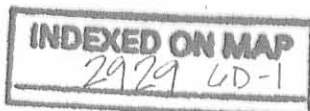

RCD 1-28-02 OK JLB

Lee Surveying and Mapping Co., Inc.

Land Surveys • Topography • Subdivisions • Construction Layout

117 N. Madriver St.
Bellefontaine OH 43311

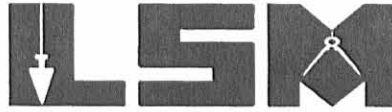

Phone: (937) 593-7335
Fax: (937) 593-7444

HOSTETLER BLANKET INGRESS/EGRESS EASEMENT

Lying in Section 28, Township 5, Range 13, Village of West Liberty, Liberty Township, Logan County, Ohio.

Being a blanket ingress/egress easement over the entire William L. Hostetler and Gladys E. Hostetler 0.056 acre tract as deeded and described in Official Record 158, Page 820 of the Logan County Records of Deeds.

Description prepared by:



ORIGINAL STAMP IN GREEN

Jeffrey I. Lee
Jeffrey I. Lee
Professional Surveyor 6359
January 9, 2002

L-3278

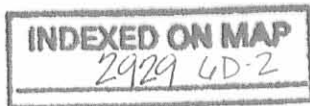

2 WORKING DAYS
BEFORE YOU DIG
 CALL TOLL FREE **800-362-2764**
 OHIO UTILITIES PROTECTION SERVICE.

LEGEND

- 5/8 INCH IRON ROD SET
- 5/8 INCH IRON ROD FOUND
- MAG NAIL SET
- ⊗ RAILROAD SPIKE FOUND
- ⊠ CONCRETE R/W MONUMENT FOUND

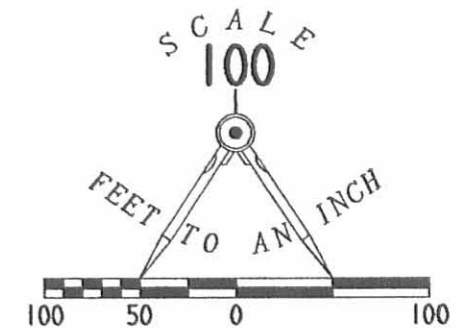

**LOCATION OF A 30 FEET WIDE
 INGRESS/EGRESS EASEMENT OVER THE
 WILLIAM L. HOSTETLER AND
 GLADYS E. HOSTETLER
 4.434 ACRE TRACTS
 OFFICIAL RECORD 165, PAGE 121 AND
 AND A BLANKET INGRESS/EGRESS EASEMENT OVER
 THE ENTIRE WILLIAM L. HOSTETLER AND
 GLADYS E. HOSTETLER
 0.056 ACRE TRACT
 OFFICIAL RECORD 158, PAGE 820
 SECTION 28, TOWN 5 RANGE 13
 VILLAGE OF WEST LIBERTY
 LIBERTY TOWNSHIP
 LOGAN COUNTY, OHIO**

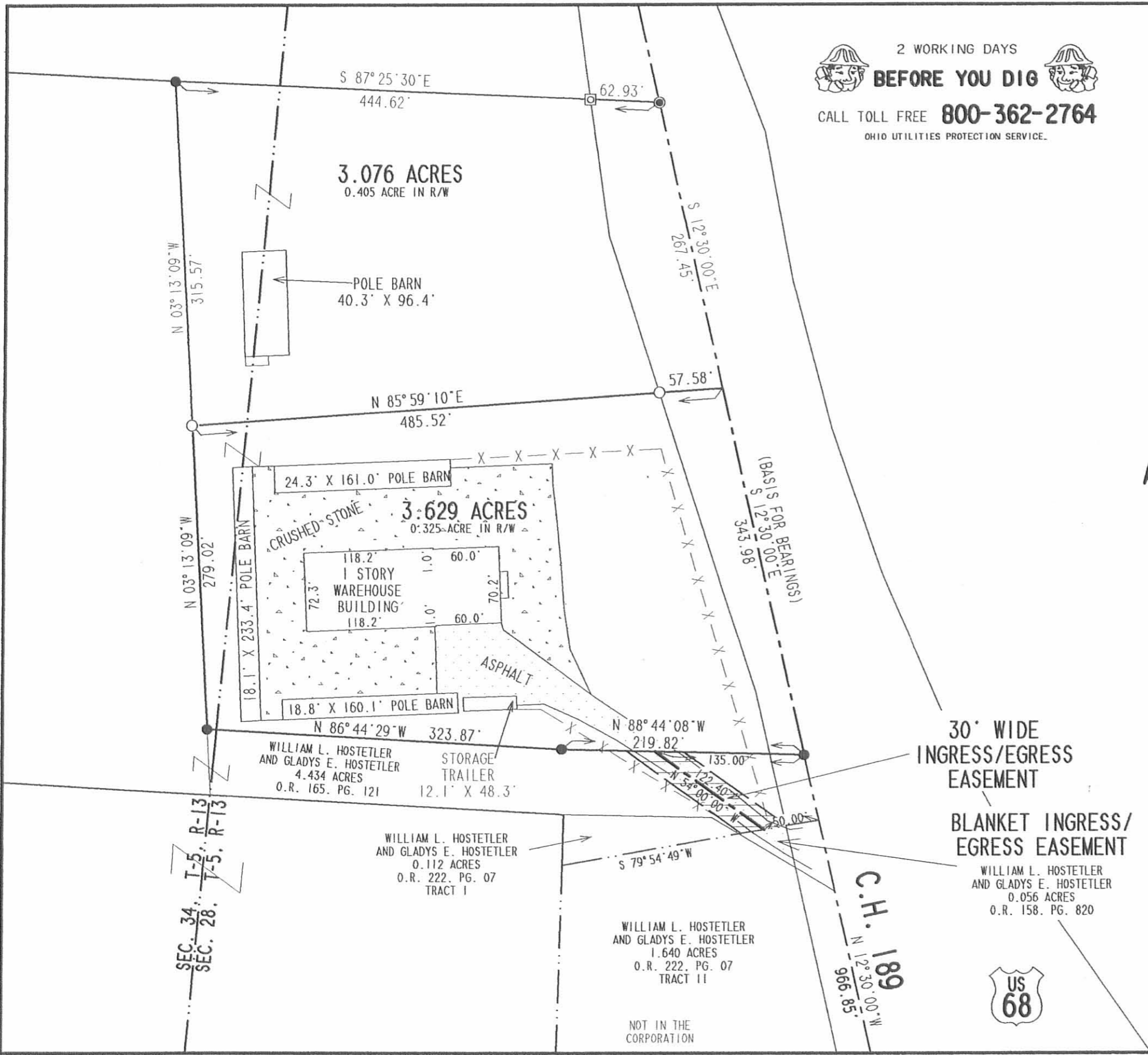

**30' WIDE
 INGRESS/EGRESS
 EASEMENT**

**BLANKET INGRESS/
 EGRESS EASEMENT**

WILLIAM L. HOSTETLER
 AND GLADYS E. HOSTETLER
 0.056 ACRES
 O.R. 158, PG. 820



SURVEYED BY:

JEFFREY L. LEE
 PROFESSIONAL SURVEYOR 6359
 DECEMBER 10, 2001

COPYRIGHT 2001 BY:
LEE SURVEYING & MAPPING CO., INC.
 117 North Madriver Street
 BELLEFONTAINE, OHIO 43311
 (937) 593-7335

D 405 MIKUNTEA L-3278-3

INDEXED ON MAP
 2929 GP

Received 7-17-89 OK 7-18-89 CLR

Lee Surveying and Mapping Co.



Farm Surveys • Lot Surveys • Topography • Subdivisions • Construction Layout

855 EAST SANDUSKY AVENUE
BELLEFONTAINE, OHIO 43311

(513) 593-5780

CLAYTON M. LEE, P.S.
JEFFREY I. LEE, P.S.

DESCRIPTION (8.183 ACRES)

Lying in Section 28, T-5, R-13, Liberty Township, Logan County, Ohio.

Being a part of that 13.815 acres (13.811 acres by survey) in the name of The Kroger Company, as deeded and described in Volume 405, Page 284 of the Logan County Records of Deeds and being more particularly described as follows:

Beginning at a 5/8" iron rod set on the center-line of County Highway 14 on the west line of said Section 28.

THENCE, with the said west line of Section 28, N 4°-44'-45" E, a distance of 311.91 feet to a 5/8" iron rod set on the south line, extended westerly, of the C. Mitchell 1.64 acre tract (Volume 375, Page 19).

THENCE, with said extended line, N 86°-12'-26" E, a distance of 348.58 feet to a 5/8" iron rod found at the southwest corner of the said 1.64 acre tract.

THENCE, with the south line of the said 1.64 acre tract, continuing N 86°-12'-26" E, a distance of 301.51 feet to a railroad spike found on the center-line of County Highway 189.

THENCE, with said highway center-line, S 12°-51'-36" E, a distance of 623.22 feet to a 'PK' nail found at the center-line inter-section of County Highway 14.

THENCE, with the center-line of County Highway 14, the following 2 bearings and distances:
N 77°-18'-20" W, 776.54 feet to a 1" iron pipe (found).
N 33°-47'-57" W, 100.00 feet to the point of beginning.

Containing 8.183 acres.

This description prepared from an actual field survey.

Basis for bearings: Center-line of County Highway 189 = S 12°-51'-36" E.

Prepared by:

Clayton M. Lee

Registered Professional Surveyor No. 6181

July 5, 1989



ORIGINAL STAMP

INDEXED ON MAP
2929701

Lee Surveying and Mapping Co.



Farm Surveys • Lot Surveys • Topography • Subdivisions • Construction Layout

855 EAST SANDUSKY AVENUE
BELLEFONTAINE, OHIO 43311

(513) 593-5780

CLAYTON M. LEE, P.S.
JEFFREY I. LEE, P.S.

DESCRIPTION (5.628 ACRES)

Lying in Sections 28 and 34, T-5, R-13, Liberty Township, Logan County, Ohio.

Being a part of that 13.815 acres (13.811 acres by survey) in the name of The Kroger Company, as deeded and described in Volume 405, Page 284 of the Logan County Records of Deeds and being more particularly described as follows:

Beginning at a 5/8" iron rod set on the center-line of County Highway 14 on the west line of said Section 28.

THENCE, with the said center-line of County Highway 14, N 33°-47'-57" W, a distance of 447.11 feet to a 1/2" iron rod found marking the southwest corner of the said 13.811 acres.

THENCE, with the west line of the said 13.811 acres, N 5°-54'-37" W, a distance of 293.76 feet to a 5/8" iron rod set at the northwest corner of the said 13.811 acres.

THENCE, with the north line of the said 13.811 acres, S 87°-13'-35" E, a distance of 655.51 feet to a 5/8" iron rod found at a northeast corner of the said 13.811 acre tract, passing into Section 28 at 337.37 feet.

THENCE, with the boundary of the W. Hostetler 28.3 acres (Volume 379, Page 123) and the boundary of the C. Mitchell 1.64 acre tract (Volume 375, Page 19), S 0°-24'-07" E, 298.14 feet to a 5/8" iron rod found at the southwest corner of the said 1.64 acre tract.

THENCE, with the south line, extended westerly, of the said 1.64 acre tract, S 86°-12'-26" W, a distance of 348.58 feet to a 5/8" iron rod set on the west line of Section 28.

THENCE, with said section line, S 4°-44'-45" W, a distance of 311.91 feet to the point of beginning.

Containing 5.628 acres, of which 2.439 acres are in Section 28 and 3.189 acres are in Section 34.

This description prepared from an actual field survey.

Basis for bearings: Center-line of County Highway 189 = S 12°-51'-36" E.

Prepared by:

Clayton M. Lee
Registered Professional Surveyor No. 6181
July 5, 1989

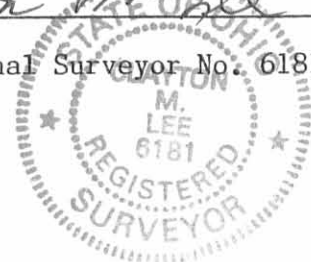

ORIGINAL STAMP IN GREEN

INDEXED ON MAP
292 9702

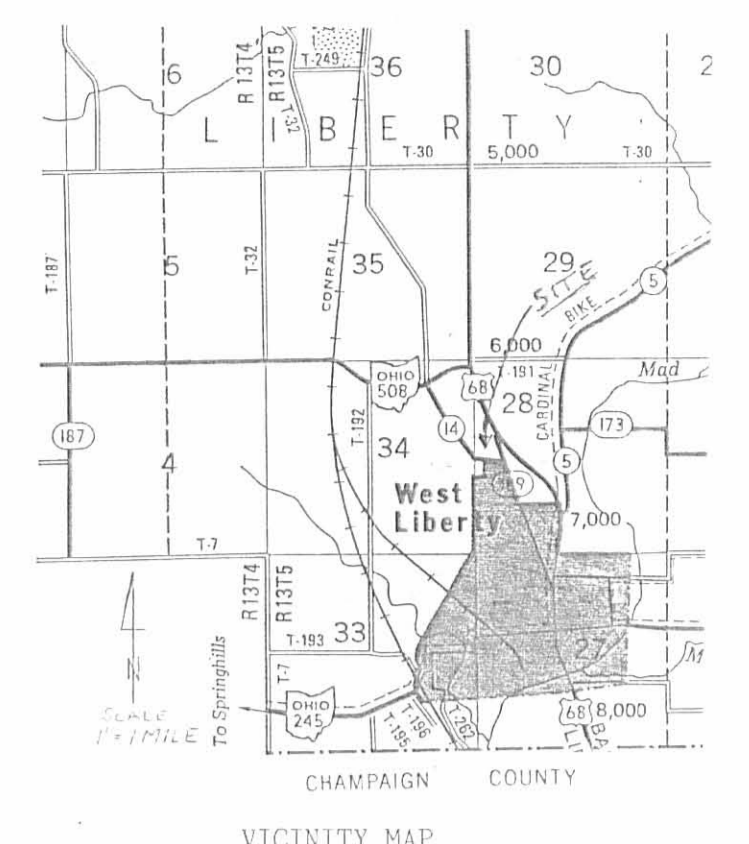

- NOTES:
- EASEMENTS AND UTILITY INFORMATION FROM RECORDS SUPPLIED BY CLIENT AND VISIBLE SURFACE STRUCTURES.
 - INFORMATION IS NOT AVAILABLE FOR ANY BURIED LOCATIONS OF RUBBISH PILLS, SLOUGHS, SPRINGS, FILLED-IN WELLS OR CISTERNS AND SEEP HOLES.
 - NO CONICAL ZONE INFORMATION FOR AIRPORTS WAS FOUND. TWO COMMERCIAL AIRPORTS ARE EACH ABOUT TEN MILES NORTH AND SOUTH OF THE SITE. SMALL GRASS PRIVATE LANDING STRIPS MAY EXIST NEARER TO THE SITE.

FLOOD INSURANCE RATE MAP
 PANEL NO. 390772 0185C ZONE C
 LOGAN COUNTY, OHIO
 DATED MAY 15, 1985
 NO OTHER FLOOD PLANE DOCUMENTS FOUND

- LEGEND
- PK NAIL FOUND
 - 1" PIPE FOUND
 - 1/2" I. ROD FOUND
 - 5/8" I. ROD SET
 - 5/8" I. ROD FOUND
 - RR SPIKE FOUND

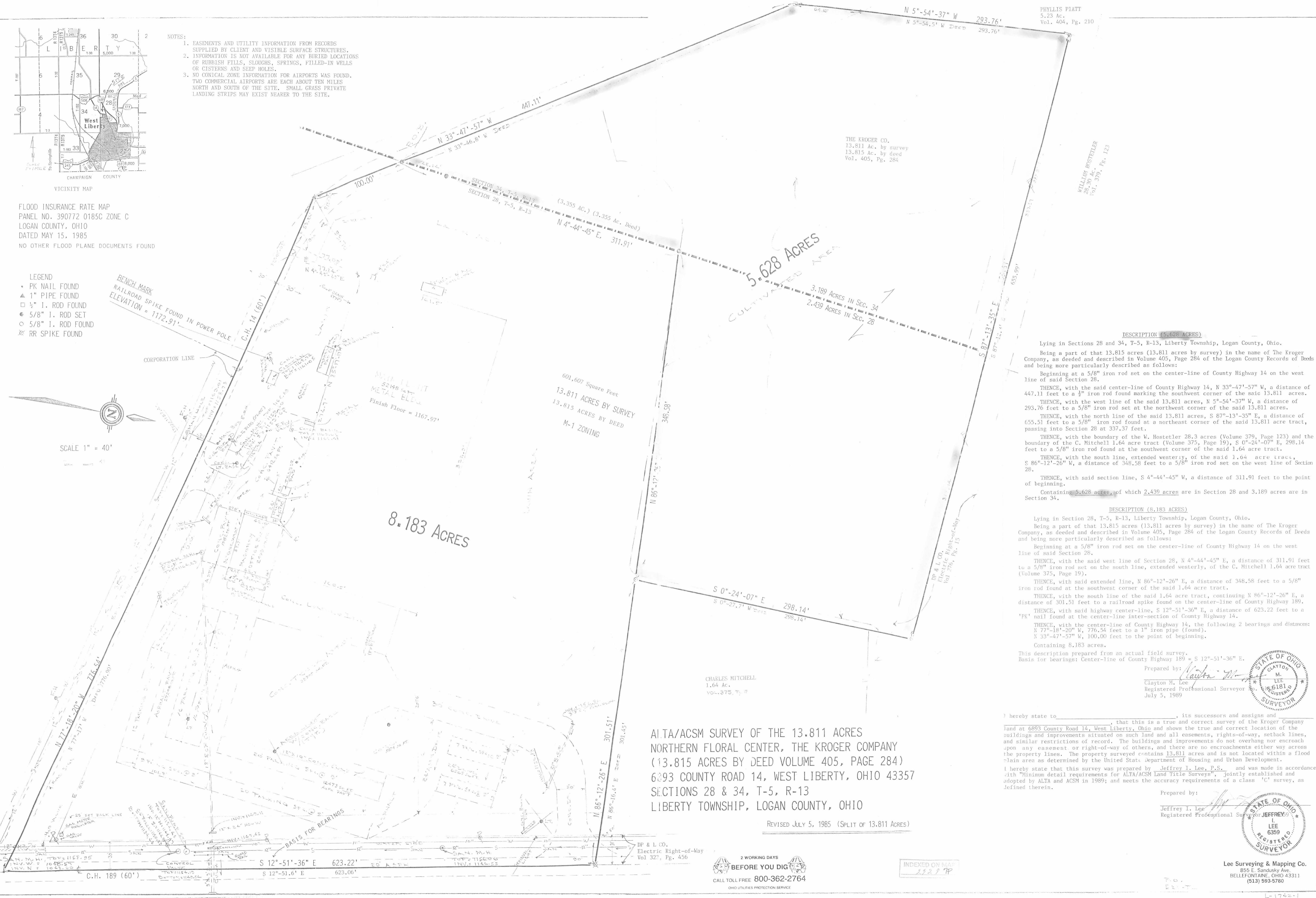
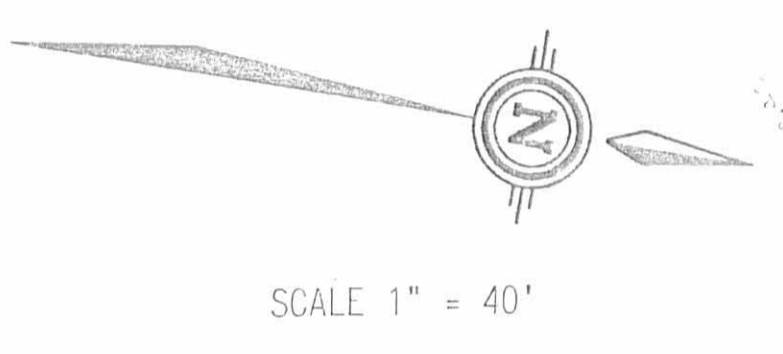

THE KROGER CO.
 13.811 Ac. by survey
 13.815 Ac. by deed
 Vol. 405, Pg. 284

WILLIAM HOSTETLER
 28.30 Ac.
 Vol. 379, Pg. 123

CHARLES MITCHELL
 1.64 Ac.
 Vol. 375, Pg. 15

ALTA/ACSM SURVEY OF THE 13.811 ACRES
 NORTHERN FLORAL CENTER, THE KROGER COMPANY
 (13.815 ACRES BY DEED VOLUME 405, PAGE 284)
 6893 COUNTY ROAD 14, WEST LIBERTY, OHIO 43357
 SECTIONS 28 & 34, T-5, R-13
 LIBERTY TOWNSHIP, LOGAN COUNTY, OHIO

REVISED JULY 5, 1985 (SPLIT OF 13.811 ACRES)

DESCRIPTION (5.628 ACRES)
 Lying in Sections 28 and 34, T-5, R-13, Liberty Township, Logan County, Ohio.
 Being a part of that 13.815 acres (13.811 acres by survey) in the name of The Kroger Company, as deeded and described in Volume 405, Page 284 of the Logan County Records of Deeds and being more particularly described as follows:
 Beginning at a 5/8" iron rod set on the center-line of County Highway 14 on the west line of said Section 28.
 THENCE, with the said center-line of County Highway 14, N 33°-47'-57" W, a distance of 447.11 feet to a 1/2" iron rod found marking the southwest corner of the said 13.811 acres.
 THENCE, with the west line of the said 13.811 acres, N 5°-54'-37" W, a distance of 293.76 feet to a 5/8" iron rod set at the northwest corner of the said 13.811 acres.
 THENCE, with the north line of the said 13.811 acres, S 87°-13'-35" E, a distance of 655.51 feet to a 5/8" iron rod found at a northeast corner of the said 13.811 acre tract, passing into Section 28 at 337.37 feet.
 THENCE, with the boundary of the W. Hostetler 28.3 acres (Volume 379, Page 123) and the boundary of the C. Mitchell 1.64 acre tract (Volume 375, Page 19), S 0°-24'-07" E, 298.14 feet to a 5/8" iron rod found at the southwest corner of the said 1.64 acre tract.
 THENCE, with the south line, extended westerly, of the said 1.64 acre tract, S 86°-12'-26" W, a distance of 348.58 feet to a 5/8" iron rod set on the west line of Section 28.
 THENCE, with said section line, S 4°-44'-45" W, a distance of 311.91 feet to the point of beginning.
 Containing 5.628 acres, of which 2.439 acres are in Section 28 and 3.189 acres are in Section 34.

DESCRIPTION (8.183 ACRES)
 Lying in Section 28, T-5, R-13, Liberty Township, Logan County, Ohio.
 Being a part of that 13.815 acres (13.811 acres by survey) in the name of The Kroger Company, as deeded and described in Volume 405, Page 284 of the Logan County Records of Deeds and being more particularly described as follows:
 Beginning at a 5/8" iron rod set on the center-line of County Highway 14 on the west line of said Section 28.
 THENCE, with the said west line of Section 28, N 4°-44'-45" E, a distance of 311.91 feet to a 5/8" iron rod set on the south line, extended westerly, of the C. Mitchell 1.64 acre tract (Volume 375, Page 19).
 THENCE, with said extended line, N 86°-12'-26" E, a distance of 348.58 feet to a 5/8" iron rod found at the southwest corner of the said 1.64 acre tract.
 THENCE, with the south line of the said 1.64 acre tract, continuing N 86°-12'-26" E, a distance of 301.51 feet to a railroad spike found on the center-line of County Highway 189.
 THENCE, with said highway center-line, S 12°-51'-36" E, a distance of 623.22 feet to a nail found at the center-line inter-section of County Highway 14.
 THENCE, with the center-line of County Highway 14, the following 2 bearings and distances: N 77°-18'-20" W, 776.54 feet to a 1" iron pipe (found).
 N 33°-47'-57" W, 100.00 feet to the point of beginning.
 Containing 8.183 acres.

This description prepared from an actual field survey.
 Basis for bearings: Center-line of County Highway 189 = S 12°-51'-36" E.

Prepared by: *Clayton M. Lee*
 Clayton M. Lee
 Registered Professional Surveyor
 July 5, 1989



I hereby state to _____, its successors and assigns and _____, that this is a true and correct survey of the Kroger Company land at 6893 County Road 14, West Liberty, Ohio and shows the true and correct location of the buildings and improvements situated on such land and all easements, rights-of-way, setback lines, and similar restrictions of record. The buildings and improvements do not overhang nor encroach upon any easement or right-of-way of others, and there are no encroachments either way across the property lines. The property surveyed contains 13.811 acres and is not located within a flood plain area as determined by the United States Department of Housing and Urban Development.

I hereby state that this survey was prepared by Jeffrey I. Lee, P.S., and was made in accordance with "Minimum detail requirements for ALTA/ACSM Land Title Surveys", jointly established and adopted by ALTA and ACSM in 1989; and meets the accuracy requirements of a class 'C' survey, as defined therein.

Prepared by:
 Jeffrey I. Lee
 Registered Professional Surveyor

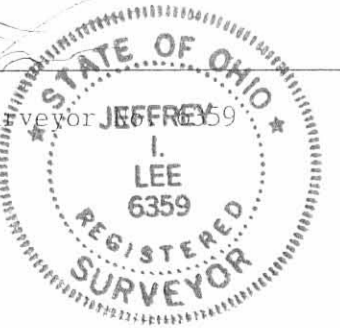

2 WORKING DAYS
 BEFORE YOU DIG
 CALL TOLL FREE 800-362-2764
 OHIO UTILITIES PROTECTION SERVICE

INDEXED ON MAP
 222 P

Lee Surveying & Mapping Co.
 855 E. Sandusky Ave.
 BELLEFONTAINE, OHIO 43311
 (513) 583-5760

Hostetler - Kroger Co. Survey Description

The following described real estate situated in the Township of Liberty, County of Logan, State of Ohio and being a part of Sections 28-34, Town 5, Range 13, B. M. R. S. and being more particularly described as follows:

Beginning at a P.K. nail in the intersection of the centerlines of C. H. No. 14 and C. H. No. 189 and an angle in the Corporation Line of West Liberty;

Thence with the centerline of C. H. No. 14, N. $77^{\circ}-17.0'$ W. 776.90 feet to an iron pipe found passing through a R. R. spike found at 591.90 feet;

Thence continuing with the centerline of C. H. No. 14, N. $33^{\circ}-46.8'$ W. 547.12 feet to an iron bar found at the most southerly corner to John E. Piatt's present 5.23 acre tract, passing through the line between Section 28 and 34 at 100.00 feet;

Thence with Piatt's east line, N. $5^{\circ}-54.5'$ W. 293.76 feet to an iron bar set;

Thence S. $87^{\circ}-12.3'$ E. 655.99 feet to an iron bar set, passing through the line between Section 34 and 28 at 355.50 feet;

Thence S. $0^{\circ}-27.7'$ W. 298.14 feet to an iron bar set at the southwest corner to Charles William Mitchell's present 1.64 acre tract, passing through an iron bar set at Mitchell's northwest corner at 47.61 feet;

Thence with Mitchell's south line, N. $86^{\circ}-16.4'$ E. 301.45 feet to a R. R. spike set in the centerline of C. H. No. 189 and being Mitchell's southeast corner;

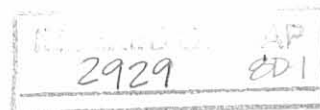

Thence with the centerline of C.H. No. 189, S. 12°-51.6' E. 623.06 feet to the place of beginning, passing through R.R. spikes found at 376.63 feet and 483.71 feet, containing 13.815 acres, more or less, of which 10.460 acres are in Section 28 and 3.355 acres are in Section 34.

The above described tract being surveyed off the south end of a 28.30 acre tract in the name of William L. Hostetler et al as recorded in Deed Vol. 379, Page 123 (9-15-1978).

I hereby certify that this is a true and accurate description of said tract as prepared by me from an actual field survey.

Daniel E. Gilbert, P.S.
Reg. Sur. No. 5402
1041 N. Main St.
Bellefontaine, Ohio 43311

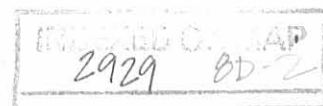

William L. Hostetler et al

John E. Platt et ux
5.23 Acres

D. P. & L. Co.
Electric Right of Way
Deed Vol. 276 Page 15
(8-14-1961)

Charles William Mitchell et ux
1.64 Acres

3.355 Acres

Total - 13.815 Acres

10.460 Acres

U.S.R. No. 68

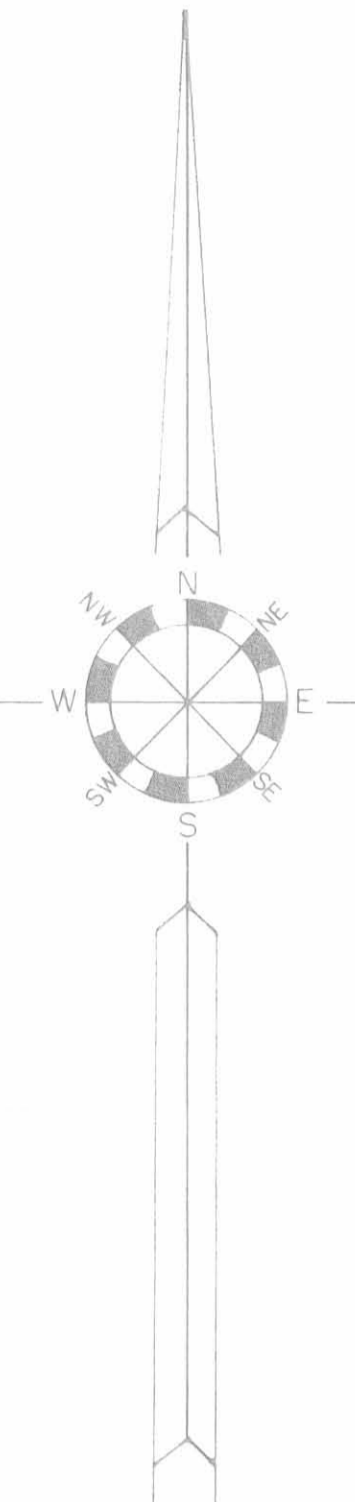

Hostetler - Kroger Co. Survey
Sections 28-34 T.5 R.13 B.M.R.S.
Liberty Township
Logan County, Ohio
October 26, 1983
Scale: 1" = 40'

"I do hereby certify that I have surveyed the property described in the caption to the hereon drawn plat and that said plat is a correct representation of said survey."

Date: October 26, 1983
Signed: *David E. Gilbert, P.S.*
Certification No. - Ohio Sur. No. 5402

INDEXED ON MAP
2429.01

Plot Revised (6-14-1984) D.E.G.

USGS Datum



Line - Smucker Survey 5.23 Acres Liberty Township May 1950

The following described land in Liberty Township, Logan County Ohio,
and being in Section 34 Town 5 Range 13.

Beginning at an iron in the center of State Highway Number 726 (State
Route Number 508) said iron being midway between two concrete
right-of-way posts and being station 463 plus 64.5 of said road as shown
in Logan County Engineer's Book 582 Page 33 and also on Logan County
Engineer's Road Plan Number X - I page 8 thence with the South side of
O.R. Byler's land S. $87^{\circ} - 37'$ E. 457.0 feet to an iron pipe said pipe
being N. $87^{\circ} - 37'$ W. 86.3 feet from a large concrete post at said Byler's
S.E. corner said post also being the S.W. corner of LaVerne Atha 14.72
acre tract thence S. $5^{\circ} - 57'$ E. 948.0 feet to an iron in the center of
State Highway Number 726 thence with the center of State Highway Number
726 N. $33^{\circ} - 47'$ W. 364.7 feet to an iron midway between two concrete
right-of-way posts and said iron being station 471 plus 12.3 of said
road thence again with the center of State Highway Number 726
N. $28^{\circ} - 06'$ W. 747.8 feet to the place of beginning said tract containing
5.23 Acres.

cc
E.K. Core
County Engineer

INDEXED ON MAP

2929 AD

Line Survey Liberty Township 28.30 Acres August 1950

The following described land in Liberty Township, Logan County Ohio, and being in Section 34 Town 5 Range 13 and section 4 Town 4 Range 13

Beginning in the center of State Highway Number 189 (U.S.Route Number 68) also known as the West Liberty and Bellefontaine Pike and the center of State Highway Number 726 (State Route Number 508) also known as the DeGraff Pike thence with the center of State Highway Number 189 N. 12° - 53' W. 1575.0 feet to the S.E. corner of LaVerne Atha's 14.72 acre tract thence with the South side of said Atha tract N. 87° - 37' W. 724.7 feet to a large concrete post at said Atha S.W. corner and also being the S.E. corner of O.R.Byler land thence with the south side of said Byler land N. 87° - 37' W. 86.3 feet to an iron pipe at the N.E. corner Smucker's, 5.23 acre tract thence with the East side of said Smucker land S. 5° - 57' E. 948.0 feet to an iron in the center of State Highway Number 726 thence with the center of State Highway Number 726 S. 33° - 47' E. 547.5 feet to an iron thence again with the center of State Highway Number 726 S. 77° - 17' E. 777.5 feet to the place of beginning said tract containing 4.55 acres in section 4 and 23.75 acres in section 34 making a total of 28.30 acres.

cc
E.K.Core
County Engineer.

INDEXED ON MAP

INDEXED ON MAP
2929
IDP

Survey No. 639

8553

Surveyed Nov. 15th 1848 for
 Henry Elc a part of Military Survey 80.
 6232 on Otter creek a branch of Mill creek
 as follows Beginning at a stake in the
 West line of said Survey on the N. Bank
 of Otter Creek thence N 78 $\frac{1}{2}$ W 29 poles
 to a stake thence N 59 W 17 $\frac{1}{2}$ poles to a stake
 in the West line of said Survey thence
 S 38 E 37 $\frac{2}{3}$ poles passing along the Orig-
 inal line to the place of beginning containing
 12 $\frac{1}{2}$ perches

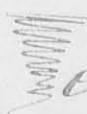

Henry Elc
 Peter Mattox  ch.ers.

O. Hays Sur. L. C. O.

Survey No. 640

2929

Surveyed Nov. 18 1848 for
 Hiram M. White a part of the N. W. gr.
 of Section 28. Town 5. Range 13 E. S. M. R.
 as follows Beginning at the S. W. corner
 of said gr. a stake from which a White
 Oak 18 S. E. bears S 15 W 38 links and a Hick
 ory 18 S. E. bears S 44 E 38 links distant
 thence East 46 poles to a stake in the West
 side of the Springfield and Sandusky Free
 Turnpike thence N 16 W 26 $\frac{10}{13}$ poles to an-
 other stake in said Free Pike thence
 West 54 poles to a stake in the East side
 of the road leading from West Liberty
 in Logan County to Maupankomotta
 in Anglitz County thence S 38 E 95 poles
 to another stake in said Road thence
 South 6 poles to the place of Beginning
 containing 8 Acres nearly

John Prater 
 Fred. Hauger  ch.ers.

O. Hays Sur. L. C. O.

INDEXED ON MAP
2929 11D-1

142

2929

Survey No 641 ✓
 Surveyed Nov. 18, 1848
 for Fred. H. Hanger a lot of land in the
 N.W. qr. of Section 28 T5. R12 E. G. M.R.
 as follows Beginning at a stake in West
 side of the State road leading from
 Bellefontaine Logan Co. to West Liberty in said
 County thence West 54 poles to a stake
 in the road leading from West Liberty
 in Logan Co. to Rappahannetta in Aug-
 laiz Co. thence N 38 W 17 poles to an-
 other stake in said Rappahannetta road
 (Near a little bridge) thence East 60.75
 poles to a stake in the West side of the
 first mentioned Road. thence S 16 E.
 12 poles to the place of beginning con-
 taining 410 Acres

John Proter

Fred. H. Hanger J. Huggins, Secy

356

Survey No 642 ✓
 Surveyed December 26th 1848
 for Fred. H. Hanger, Sander Hen-
 per John and Nathaniel Kelly and H.
 M. White the N. W. of Section No. 29 Town
 5 Range 13 E. G. Miami River as follows
 1st for S. Kemper the E. 1/2 of the N. E.
 qr. of said section Beginning at the N. E.
 corner of said section at a stake from
 which a White Oak 10 in. originally bore
 N 55 W 18 links and a Black Oak 18 in. 57
 links exist (Both said to be gone) a White O.
 Stump still standing taken by me as the
 stump of one of said bearing trees,
 thence N 1/2 W 40 chains to a stake in the
 East line of said section thence S 87 1/2 W

Rec'd 5/23/14

✓ APPROVED **Lee Surveying and Mapping Co., Inc.**

Land Surveys • Topography • Subdivisions • Construction Layout

117 N. Madriver St.
Bellefontaine OH 43311



Phone: (937) 593-7335
Fax: (937) 593-7444
surveys@lsminc.us

PIATT 0.029 ACRE

Lying in Section 34, Town 5, Range 13, Liberty Township, Logan County, Ohio.

Being out of the David M. Piatt and Cheryl L. Piatt 1.905 acre tract as deeded and described in Official Record 466, Page 892 of the Logan County Records of Deeds and being more particularly described as follows:

Commencing on a 3/4 inch iron pipe found on the center-line of County Highway 14 on the southwest corner of Woodland Rest Allotment (Plat Cabinet A, Slide 345).

THENCE, with the center-line of County Highway 14 (60 feet wide), S 40°-01'-01"E, a distance of 529.02 feet to a MAG nail found at the TRUE POINT OF BEGINNING, passing a MAG nail set at 379.02 feet.

THENCE, with the southerly line of the Phyllis E. Piatt aka Phyllis E. Piatt Young and Roland Young 3.334 acre tract (O.R. 430, Pg. 316), N 50°-40'-27"E, a distance of 272.08 feet to a 5/8 inch iron rod found, passing a 5/8 inch iron rod found at 29.95 feet.

THENCE, with the west line of the remainder of the William L. Hostetler 12.845 acre tract (O.R. 158, Pg. 815), S 17°-49'-19"E, a distance of 10.02 feet to a 5/8 inch iron rod set.

THENCE, S 52°-39'-47"W, a distance of 268.56 feet to the point of beginning, passing a 5/8 inch iron rod set at 238.53 feet.

Containing 0.029 acre.

Property is subject to any and all previous easements and rights-of-way of record.

This parcel is to be attached to an adjoining tract of land and is not to be used as a separate and independent parcel.

The basis for bearings is the center-line of County Highway 14, being S 40°-01'-01"E, and all other bearings are from angles and distances measured in a field survey by Lee Surveying and Mapping Co., Inc. on May 20, 2014.

Description prepared by:

William K. Bruce

William K. Bruce
Professional Surveyor 7437
May 20, 2014

57420514



ORIGINAL STAMP IN GREEN

INDEXED ON MAP
2929 11D-1

Lee Surveying and Mapping Co., Inc.



Land Surveys • Topography • Subdivisions • Construction Layout

117 N. Madriver St.
Bellefontaine OH 43311



Phone: (937) 593-7335
Fax: (937) 593-7444
surveys@lsminc.us

YOUNG 0.913 ACRE

Lying in Section 34, Town 5, Range 13, Liberty Township, Logan County, Ohio.

Being out of the Phyllis E. Piatt aka Phyllis E. Piatt Young and Roland Young 3.334 acre tract as deeded and described in Official Record 430, Page 316 of the Logan County Records of Deeds and being more particularly described as follows:

Commencing on a 3/4 inch iron pipe found on the center-line of County Highway 14 on the southwest corner of Woodland Rest Allotment (Plat Cabinet A, Slide 345).

THENCE, with the center-line of County Highway 14 (60 feet wide), S 40°-01'-01"E, a distance of 379.02 feet to a MAG nail set at the TRUE POINT OF BEGINNING.

THENCE, N 56°-41'-34"E, a distance of 321.47 feet to a 5/8 inch iron rod set, passing a 5/8 inch iron rod set at 30.21 feet.

THENCE, with the west line of the remainder of the William L. Hostetler 12.845 acre tract (O.R. 158, Pg. 815), S 17°-49'-19"E, a distance of 124.98 feet to a 5/8 inch iron rod found.

THENCE, with the northerly line of the David M. Piatt and Cheryl L. Piatt 1.905 acre tract (O.R. 466, Pg. 892), S 50°-40'-27"W, a distance of 272.08 feet to a MAG nail found on the center-line of County Highway 14, passing a 5/8 inch iron rod found at 242.13 feet.

THENCE, with the center-line of County Highway 14, N 40°-01'-01"W, a distance of 150.00 feet to the point of beginning.

Containing 0.913 acre, of which 0.102 acre is within the highway right-of-way.

Property is subject to any and all previous easements and rights-of-way of record.

The basis for bearings is the center-line of County Highway 14, being S 40°-01'-01"E, and all other bearings are from angles and distances measured in a field survey by Lee Surveying and Mapping Co., Inc. on May 20, 2014.



ORIGINAL STAMP IN GREEN

Description prepared by:

William K. Bruce

William K. Bruce
Professional Surveyor 7437
May 20, 2014

57420514

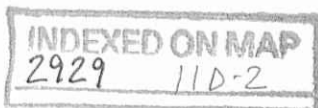

APPROVED

Rec'd 5/23/14

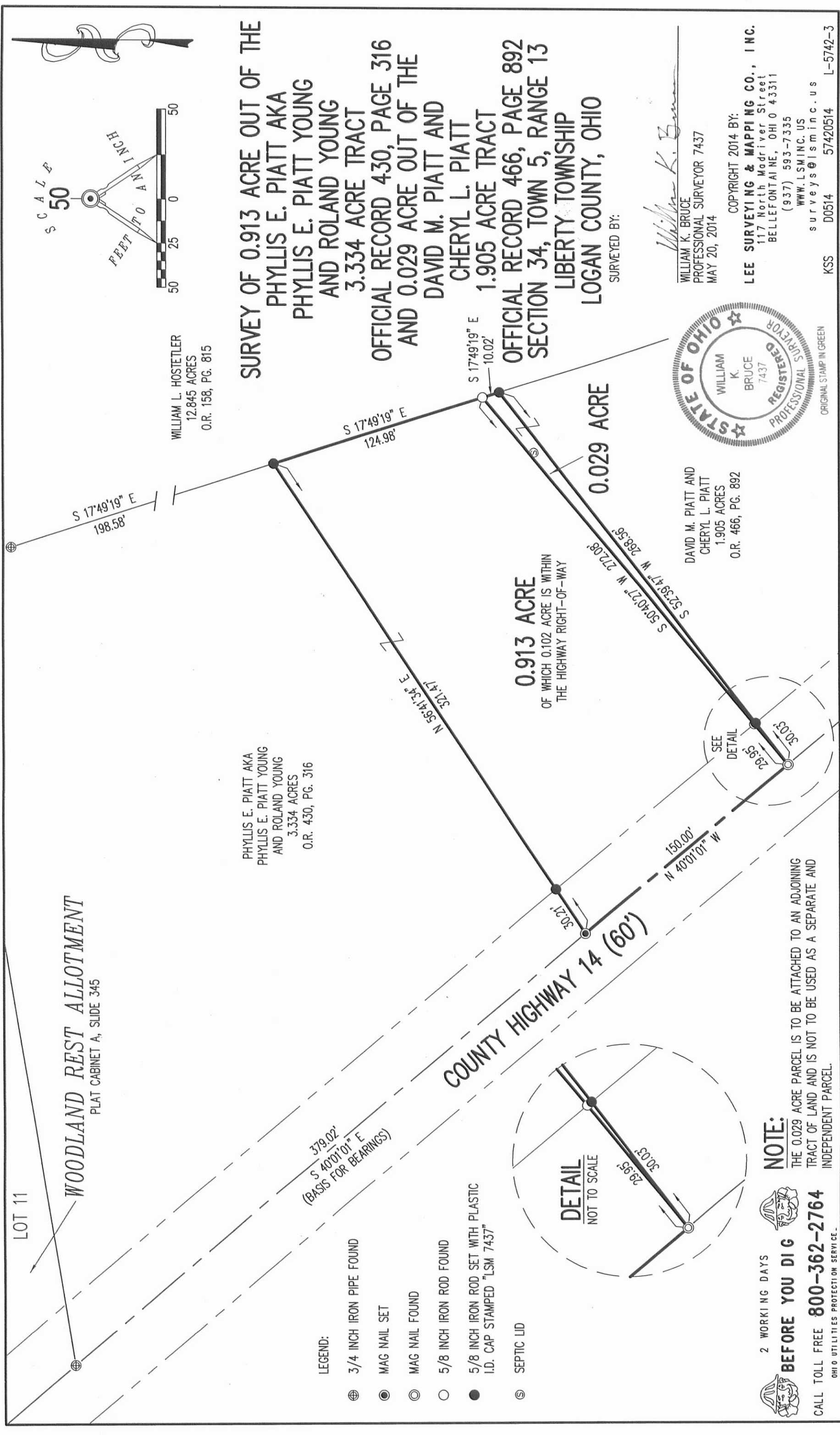

WOODLAND REST ALLOTMENT
 PLAT CABINET A, SLIDE 345

WILLIAM L. HOSTETLER
 12.845 ACRES
 O.R. 158, PG. 815

PHYLLIS E. PIATT AKA
 PHYLLIS E. PIATT YOUNG
 AND ROLAND YOUNG
 3.334 ACRES
 O.R. 430, PG. 316

**SURVEY OF 0.913 ACRE OUT OF THE
 PHYLLIS E. PIATT AKA
 PHYLLIS E. PIATT YOUNG
 AND ROLAND YOUNG
 3.334 ACRE TRACT
 OFFICIAL RECORD 430, PAGE 316
 AND 0.029 ACRE OUT OF THE
 DAVID M. PIATT AND
 CHERYL L. PIATT
 1.905 ACRE TRACT
 OFFICIAL RECORD 466, PAGE 892
 SECTION 34, TOWN 5, RANGE 13
 LIBERTY TOWNSHIP
 LOGAN COUNTY, OHIO**

0.913 ACRE
 OF WHICH 0.102 ACRE IS WITHIN
 THE HIGHWAY RIGHT-OF-WAY

0.029 ACRE

DAVID M. PIATT AND
 CHERYL L. PIATT
 1.905 ACRES
 O.R. 466, PG. 892



WILLIAM K. BRUCE
 PROFESSIONAL SURVEYOR 7437
 MAY 20, 2014

COPYRIGHT 2014 BY:
LEE SURVEYING & MAPPING CO., INC.
 117 North Modriver Street
 BELLEFONTAINE, OHIO 43311
 (937) 593-7335
 WWW.LSMINC.US

surveys@lsminc.us
 KSS D0514 57420514 L-5742-3

LEGEND:

- ⊕ 3/4 INCH IRON PIPE FOUND
- MAG NAIL SET
- ◎ MAG NAIL FOUND
- 5/8 INCH IRON ROD FOUND
- 5/8 INCH IRON ROD SET WITH PLASTIC I.D. CAP STAMPED "LSM 7437"
- ⊙ SEPTIC LID

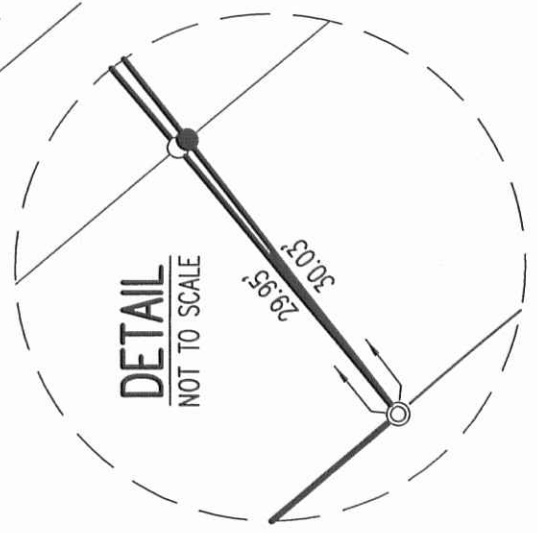

NOTE:

THE 0.029 ACRE PARCEL IS TO BE ATTACHED TO AN ADJOINING TRACT OF LAND AND IS NOT TO BE USED AS A SEPARATE AND INDEPENDENT PARCEL.

2 WORKING DAYS
BEFORE YOU DIG
 CALL TOLL FREE **800-362-2764**
 OHIO UTILITIES PROTECTION SERVICE

INDEXED ON MAP
 2929 11P

7-20-16

APPROVED

Situated in the Village of West Liberty, County of Logan, State of Ohio, and being a part of Liberty Township Section 28 Township 5, Range 13, also known as being all of a 0.112 acre (Tract I) parcel and all of a 1.584 acre (Tract II) parcel of land conveyed to William L. Hostetler as recorded in O.R. 1221, Page 187 of said county's records, and being further bounded and described as follows:

Commencing at a magnail set at the centerline intersection of Township Road 14 and Township Road 189, thence along the centerline of said Township Road 189, N 12° 40' 30" W for a distance of 623.06 feet to a magnail set at the northeast corner of a 8.183 acre parcel of land conveyed to The Kroger Co. as recorded in O.R. Vol. 758, Page 429, said northeast corner being the **POINT OF BEGINNING** of the parcel of land herein after described, thence clockwise along the following five (5) courses and distances:

1. Thence along the north line of said The Kroger Co., S 86° 31' 26" W for a distance of 301.36 feet to a 5/8 inch rebar found at a southeast corner of a 13.815 acre parcel of land conveyed to The Kroger Co. as recorded in D.B. Vol. 405, Page 284, passing over a 5/8 inch rebar with cap "GPD" set on the West Right of Way line of said Township Road 189 at 30.39 feet;
2. Thence along the east line of said The Kroger Co. 13.815 acre parcel, N 0° 34' 20" E for a distance of 297.98 feet to a 5/8 inch rebar found on the South line of a 4.434 acre parcel of land conveyed to William L. Hostetler as recorded in O.R. Vol. 1221, Page 178 as parcel 3;
3. Thence along the south line of said 4.434 acre William L. Hostetler parcel, S 88° 52' 02" E for a distance of 139.20 feet to a Capped 5/8" Rebar "WGL 5105" found;
4. Thence continuing along said south line and the south line of a 0.056 acre parcel of land conveyed to William L. Hostetler as recorded in O.R. Vol. 1221, Page 178 as parcel 2, S 58° 46' 53" E for a distance of 130.48 feet to a 5/8 inch rebar found on the centerline of said Township Road 189, passing over a 5/8 inch rebar found at the northwest corner of said 0.056 acre William L. Hostetler parcel at 28.80 feet and a 5/8 inch rebar with cap "GPD" set on the west right of way line of said Township Road 189 at 88.85 feet;
5. Thence along said centerline, S 12° 40' 30" E for a distance of 214.54 feet, to the True Point of Beginning and containing 1.6971 acres (73,928 sq.ft.) of land, 0.156 acres located in the right of way of said Township Road 189, more or less, and subject to all easements, restrictions and covenants of record as surveyed under the supervision of James E. Karing, P.S. number 7539, for Glaus, Pyle, Schomer, Burns & DeHaven, Inc., dba GPD Group, in June of 2016.

All bearings referred to herein, are relative to grid north of the Ohio State Plane Coordinate System, North Zone, NAD 83 (2011) Geoid 12A, as determined from GNSS measurements tied to the Ohio Department of Transportation's VRS system

Glaus, Pyle, Schomer, Burns & DeHaven, Inc.
dba GPD Group



Steven L. Mullaney 6/30/16
Steven L. Mullaney, P.S. 7900

INDEXED ON MAP
2929 12D

CONSOLIDATION PLAT

PART OF LIBERTY TOWNSHIP SECTION 28

T 5, R 13

VILLAGE OF WEST LIBERTY

COUNTY OF LOGAN

STATE OF OHIO

- LEGEND:**
- EXISTING IRON PIN FOUND AS NOTED
 - × MAG NAIL SET
 - 5/8" x 30" REBAR WITH CAP "GPD" SET
 - P/L - EXISTING PROPERTY LINE
 - R/W - EXISTING RIGHT OF WAY LINE
 - C/L - EXISTING CENTER LINE
 - P.O.C. POINT OF COMMENCEMENT
 - P.O.B. TRUE POINT OF BEGINNING

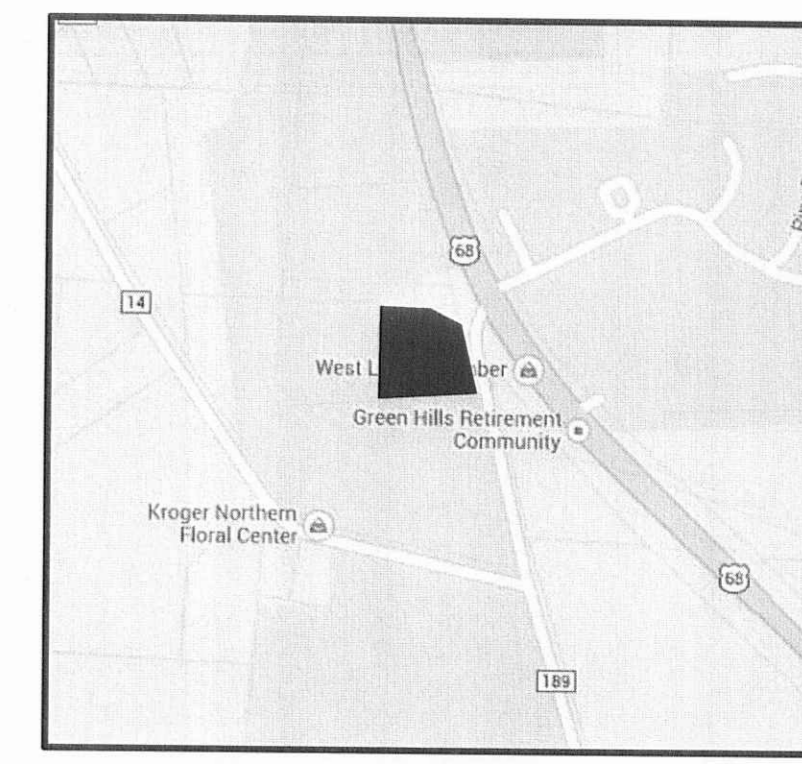

LOCATION MAP

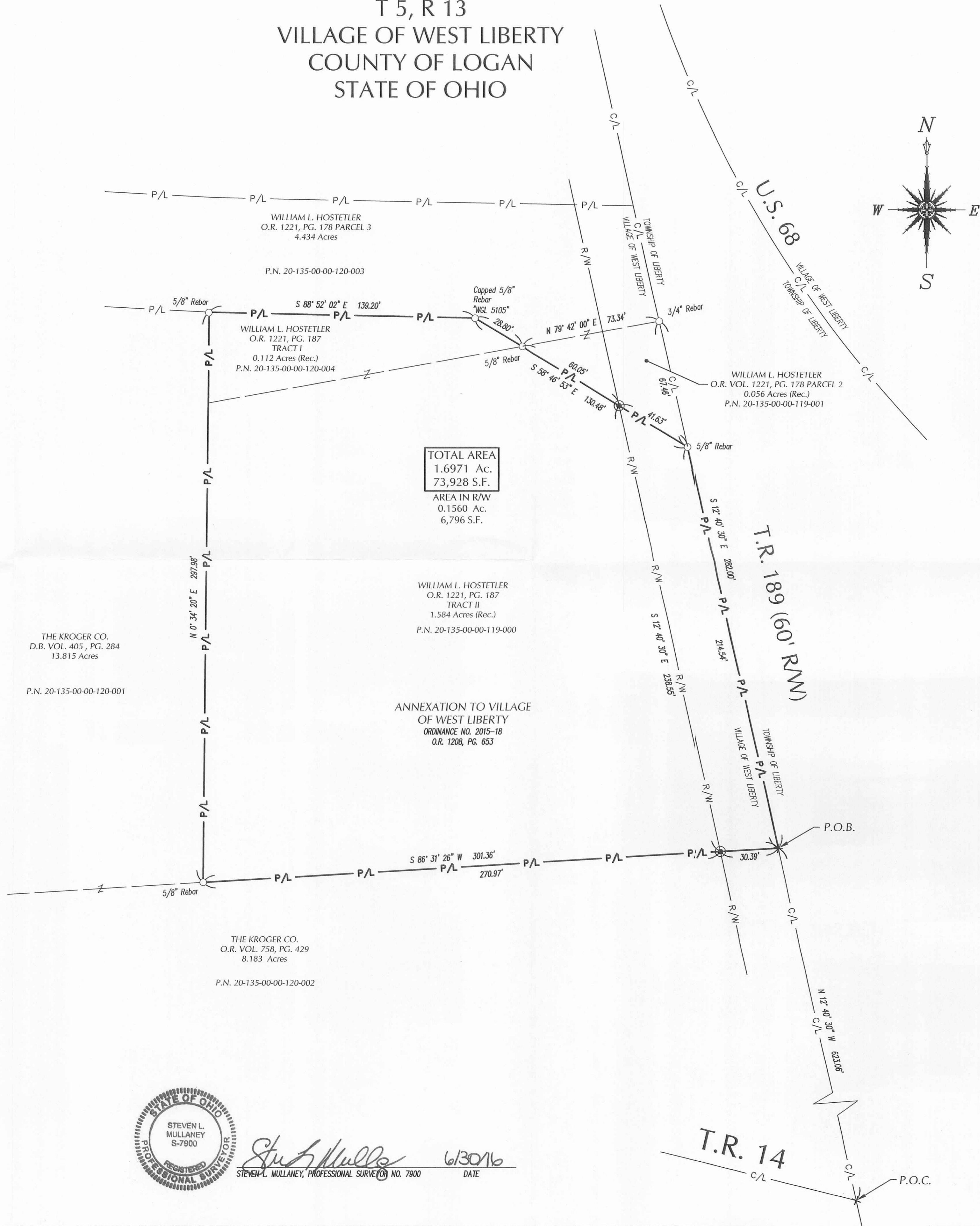
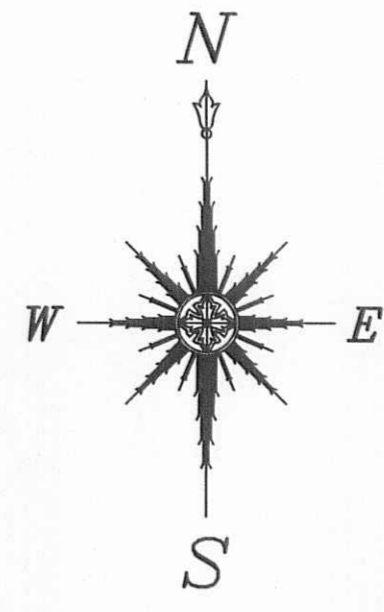

TOTAL AREA
 1.6971 Ac.
 73,928 S.F.
 AREA IN R/W
 0.1560 Ac.
 6,796 S.F.

BASIS OF BEARING:
 STATE PLANE GRID NORTH, NAD 83 (2011),
 GEOID 12A, OHIO NORTH ZONE.
 TIED BY GNSS TO THE O.D.O.T. WS.

- REFERENCES:**
1. COUNTY TAX MAP.
 2. DEEDS.
 3. PLATS.

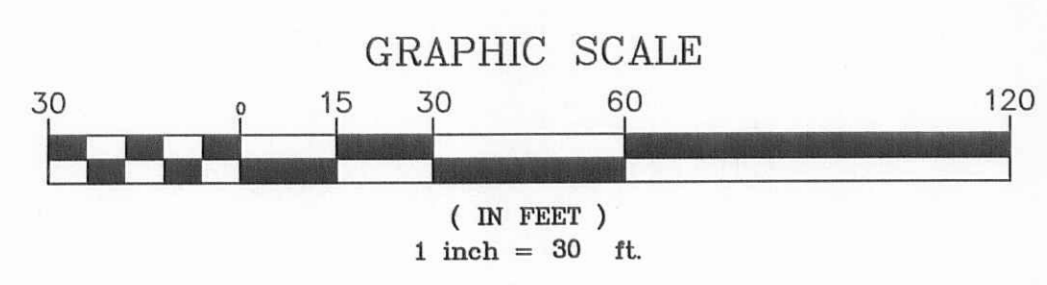

Steven L. Mullaney
 STEVEN L. MULLANEY, PROFESSIONAL SURVEYOR NO. 7900
 DATE 6/30/16

REV. DATE	DESCRIPTION

WEST LIBERTY, OH 43357

ISSUED FOR:	
PERMIT	-
BID	-
CONSTRUCTION	-
RECORD	-
PROJECT MANAGER	DESIGNER
SLM	JEK

JOB NO.
2015066.01

1 of 1

INDEXED ON MAP
 2929 12P

ANNEXATION MAP

1.6414 AC. TO THE VILLAGE OF WEST LIBERTY

PART OF SECTION 28
T 5, R 13
TOWNSHIP OF LIBERTY
COUNTY OF LOGAN
STATE OF OHIO

BASIS OF BEARING:
STATE PLANE GRID NORTH, NAD 83 (2011),
GEOID 12A, OHIO NORTH ZONE.
TIED BY GPS TO THE O.D.O.T. VRS.

REFERENCES:
1. COUNTY TAX MAP.
2. DEEDS.
3. PLATS.

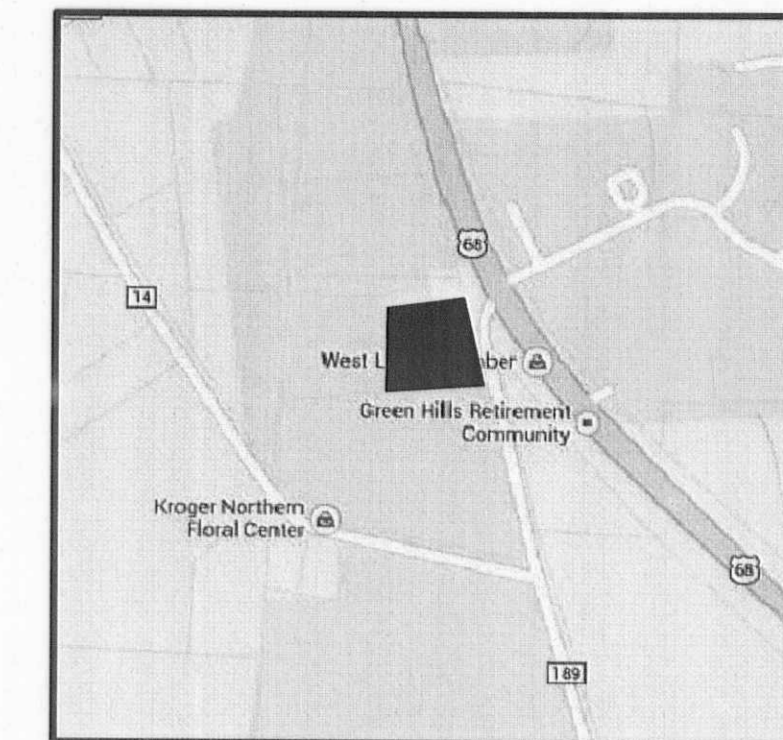

LOCATION MAP

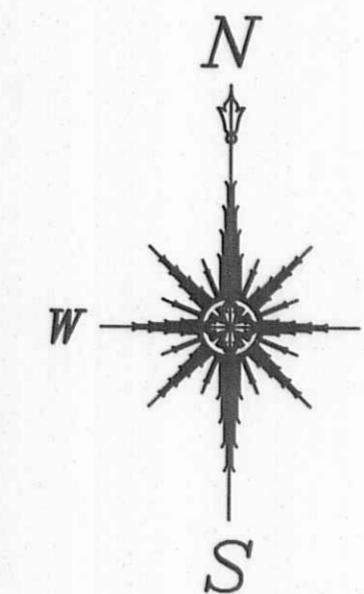

DESCRIPTION:

SITUATED IN THE TOWNSHIP OF LIBERTY, COUNTY OF LOGAN, STATE OF OHIO, AND BEING A PART OF SECTION 28, TOWNSHIP 5, RANGE 13, ALSO KNOWN AS BEING ALL OF A 1.584 ACRE PARCEL OF LAND CONVEYED TO WILLIAM L. HOSTETLER AND GLADYS E. HOSTETLER AS RECORDED IN O.R. VOL. 222, PAGE 7 (TRACT II) AND ALL OF A 0.056 ACRE PARCEL OF LAND CONVEYED TO WILLIAM L. HOSTETLER AND GLADYS E. HOSTETLER AS RECORDED IN O.R. VOL. 158, PAGE 820 OF SAID COUNTY'S RECORDS, AND BEING FURTHER BOUNDED AND DESCRIBED AS FOLLOWS:

COMMENCING AT A POINT AT THE CENTERLINE INTERSECTION OF TOWNSHIP ROAD 14 AND TOWNSHIP ROAD 189, THENCE ALONG THE CENTERLINE OF SAID TOWNSHIP ROAD 189, N 12° 40' 30" W FOR A DISTANCE OF 623.06 FEET TO A POINT AT THE NORTHEAST CORNER OF A 8.183 ACRE PARCEL OF LAND CONVEYED TO THE KROGER CO. AS RECORDED IN O.R. VOL. 758, PAGE 429, SAID NORTHEAST CORNER BEING THE TRUE POINT OF BEGINNING OF THE PARCEL OF LAND HEREINAFTER DESCRIBED, THENCE CLOCKWISE ALONG THE FOLLOWING FOUR (4) COURSES AND DISTANCES:

1. THENCE ALONG THE NORTH LINE OF SAID THE KROGER CO., S 86° 31' 26" W FOR A DISTANCE OF 301.36 FEET TO A 5/8 INCH REBAR FOUND AT A SOUTHEAST CORNER OF A 13.815 ACRE PARCEL OF LAND CONVEYED TO THE KROGER CO. AS RECORDED IN D.B. VOL. 405, PAGE 284;
2. THENCE ALONG THE EAST LINE OF SAID THE KROGER CO. 13.815 ACRE PARCEL, N 0° 34' 20" E FOR A DISTANCE OF 250.45 FEET TO A POINT AT THE SOUTHWEST CORNER OF A 0.112 ACRE PARCEL CONVEYED TO WILLIAM L. HOSTETLER AND GLADYS E. HOSTETLER IN O.R. VOL. 22, PAGE 7 (TRACT I);
3. THENCE ALONG THE SOUTH LINE OF SAID TRACT I AND A SOUTH LINE OF A 4.434 ACRE PARCEL OF LAND CONVEYED TO WILLIAM L. HOSTETLER AND GLADYS E. HOSTETLER AS RECORDED IN O.R. VOL. 165, PAGE 121, N 79° 42' 00" E FOR A DISTANCE OF 240.30 FEET TO A 3/4 INCH REBAR FOUND ON THE CENTERLINE OF SAID TOWNSHIP ROAD 189, PASSING OVER A 5/8 INCH REBAR FOUND AT 166.97 FEET;
4. THENCE ALONG SAID CENTERLINE, S 12° 40' 30" E FOR A DISTANCE OF 282.00 FEET, PASSING A 5/8 REBAR FOUND AT 67.46 FEET TO THE TRUE POINT OF BEGINNING AND CONTAINING 1.6414 ACRES (71,497 SQ.FT.) OF LAND, MORE OR LESS, AND SUBJECT TO ALL EASEMENTS, RESTRICTIONS AND COVENANTS OF RECORD AS SURVEYED UNDER THE SUPERVISION OF STEVEN L. MULLANEY, P.S. NUMBER 7900, FOR GLAUS, PYLE, SCHOMER, BURNS & DEHAVEN, INC., DBA GPD GROUP, IN FEBRUARY OF 2015.

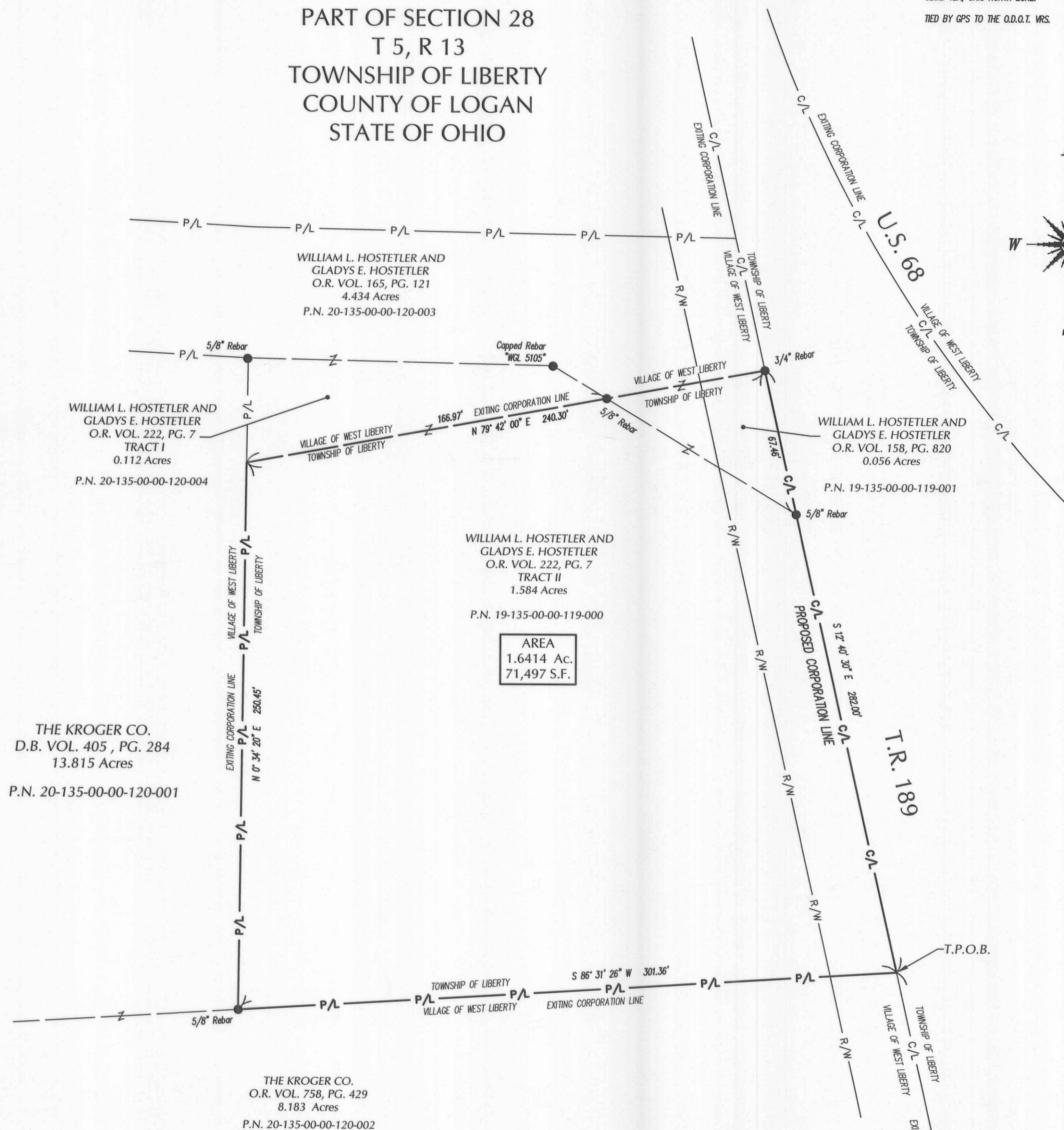

AREA
1.6414 Ac.
71,497 S.F.

THE KROGER CO.
D.B. VOL. 405, PG. 284
13.815 Acres
P.N. 20-135-00-00-120-001

THE KROGER CO.
O.R. VOL. 758, PG. 429
8.183 Acres
P.N. 20-135-00-00-120-002

LEGEND:

- EXISTING IRON PIN FOUND AS NOTED
- P/L - EXISTING PROPERTY LINE
- R/W - EXISTING RIGHT OF WAY LINE
- C/L - EXISTING CENTER LINE
- P.O.C. POINT OF COMMENCEMENT
- T.P.O.B. TRUE POINT OF BEGINNING

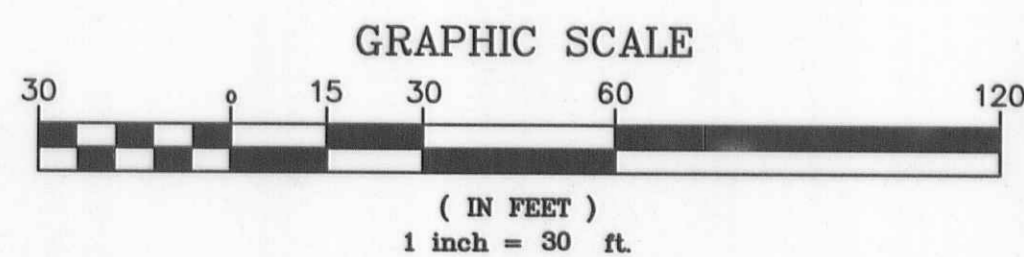

SURVEYOR'S AFFIDAVIT:

THE ABOVE ANNEXATION MAP WAS PREPARED FROM A SURVEY DONE UNDER MY DIRECT SUPERVISION IN FEBRUARY OF 2015.

Steven L. Mullaney
STEVEN L. MULLANEY, PROFESSIONAL SURVEYOR NO. 7900
DATE 2/25/2015

LOGAN COUNTY COMMISSIONERS: *[Signature]* 10-1-2015 DATE
[Signature] 10/1/15 DATE
[Signature] 10/1/15 DATE
LOGAN COUNTY ENGINEER: *[Signature]* 9-30-15 DATE
CHAIRMAN, TOWNSHIP TRUSTEES: _____ DATE
L.U.C. PLANNING DIRECTOR: _____ DATE
MAYOR OF WEST LIBERTY: *[Signature]* 2-1-16 DATE
PRESIDENT VILLAGE COUNCIL: *[Signature]* 2/2/16 DATE
PLAT PRE-APPROVED: *[Signature]* 6-19-15 DATE
PLAT CHECKED: *[Signature]* 2-11-16 DATE
VILLAGE ORDINANCE NUMBER: 2015-19 12520 DATE
TRANSFERRED THIS 11th DAY OF February, 2016
LOGAN COUNTY AUDITOR: *[Signature]*
RECEIVED FOR RECORD AT 2:20 O'CLOCK P. M.
THIS 11th DAY OF February, 2016
LOGAN COUNTY RECORDER: *[Signature]*
RECORDED IN PLAT CABINET B, SLIDE 135A

REV.	DATE	DESCRIPTION

WEST LIBERTY, OH 43357

ISSUED FOR:	
PERMIT	-
BID	-
CONSTRUCTION	-
RECORD	-
PROJECT MANAGER	DESIGNER
SLM	JEK

JOB NO.
2015066.01

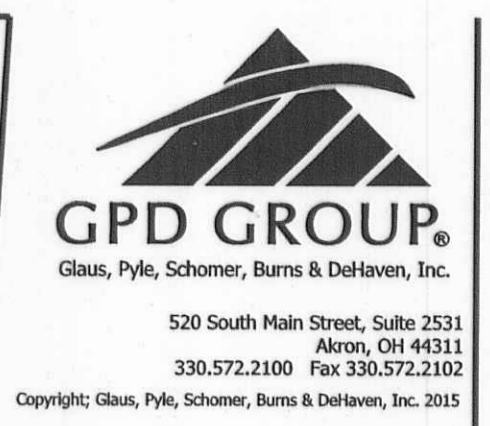

1-23-18

APPROVED



EDWARDS SURVEYING

110 South Main Street
Urbana, Ohio 43078
(937) 653-6508



LEGAL DESCRIPTION FOR WIRICK'S 5.211 ACRE TRACT

Being situate in the State of Ohio, County of Logan, Village of West Liberty, Liberty Township, and being a part of Section 34, Town 5, Range 13, B.T.M.R.S., and being more particularly described as follows:

Beginning for reference at a 3/4" diameter iron pipe found on the centerline of Township Road 14 (60' right-of-way) at the Southwest corner of Woodland Rest Allotment as recorded in Plat Cabinet "A", Slide 345, of the Logan County Records;

Thence with the South line of said Woodland Rest Allotment and the North line of a 3.334 acre tract conveyed to David M. and Deborah M. Piatt by deed recorded in Official Record 1159, Page 26, S-87°19'56"-E, 457.77'(feet) to a 3/4" diameter iron pipe found at the **PRINCIPLE PLACE OF BEGINNING** for the tract hereinafter described;

Thence continuing with the South line of Woodland Rest Allotment and with the South line of an 18.52 acre tract conveyed to LANDEX by deed recorded in Official Record 176, Page 902, S-87°38'45"-E, 362.60'(feet) to a 5/8" diameter iron bar found at the Northwest corner of a 3.076 acre tract conveyed to Wesley and Susan Krabill by deed recorded in Official Record 1112, Page 597, Tract 1, passing for reference a concrete post found at the Southeast corner of Woodland Rest Allotment at 86.00'(feet);

Thence with the West line of said Krabill's tract, the West line of a 3.657 acre tract also conveyed to Wesley and Susan Krabill by deed recorded in Official Record 1112, Page 597, Tract 2, and with the West line of a 0.777 acre tract conveyed to Neil Wirick, Trustee, by deed recorded in Official Record 1285, Page 373, Parcel III, S-3°25'30"-E, 654.71'(feet) to an iron bar set on the North line of a 13.815 acre tract conveyed to The Kroger Co. by deed recorded in Deed Volume 405, Page 284, of the Logan County Deed Records, passing for reference a 5/8" diameter iron bar found at 315.57'(feet) and a 5/8" diameter iron bar found at 594.59'(feet);

Thence with the North line of said Kroger's tract, N-86°59'59"-W, 336.92'(feet) to a 5/8" diameter iron bar found on the East line of a 1.905 acre tract conveyed to David M. and Cheryl L. Piatt by deed recorded in Official Record 466, Page 892, of the Logan County Records;

Thence with the East line of said 1.905 acre tract, the East line of a 0.029 acre tract conveyed to Darren L. and Angela L. Dixon by deed recorded in Official Record 1197, Page 601, the East line of a 0.913 acre tract also conveyed to Darren L. and Angela L. Dixon by deed recorded in Official Record 1197, Page 598, and with the East line of aforementioned Piatt's 3.334 acre tract, N-5°41'57"-W, 654.04'(feet) to the place of beginning, passing for reference 5/8" diameter iron bars found at 320.60'(feet) and at 455.46'(feet).

Containing 5.211 acres but being subject to the rights of all legal highways and all easements of record.

Being a more accurate description of the remaining area of an original 28.30 acre tract conveyed to Neil Wirck by deed recorded in Official Record 1285, Page 373, Parcel I, of the Logan County Records.

The foregoing description prepared by and in accordance with a survey by William D. Edwards, Professional Surveyor No. 7574, January 4, 2018. All iron bars set are 5/8"x30" iron re-bar with a yellow plastic cap stamped "EDWARDS PS 7574". Bearings are based on the South line of Woodland Rest Allotment per an assumed bearing of S-87°19'56"-E.

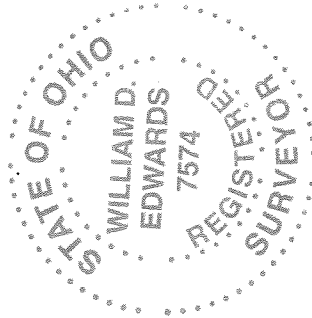

William D. Edwards, P.S. 7574

INDEXED ON MAP
2929

APPROVED
1-23-18

PLAT OF SURVEY

VILLAGE OF WEST LIBERTY

LIBERTY TOWNSHIP, LOGAN COUNTY, OHIO

SECTION 34, TOWN 5, RANGE 13, B.T.M.R.S.

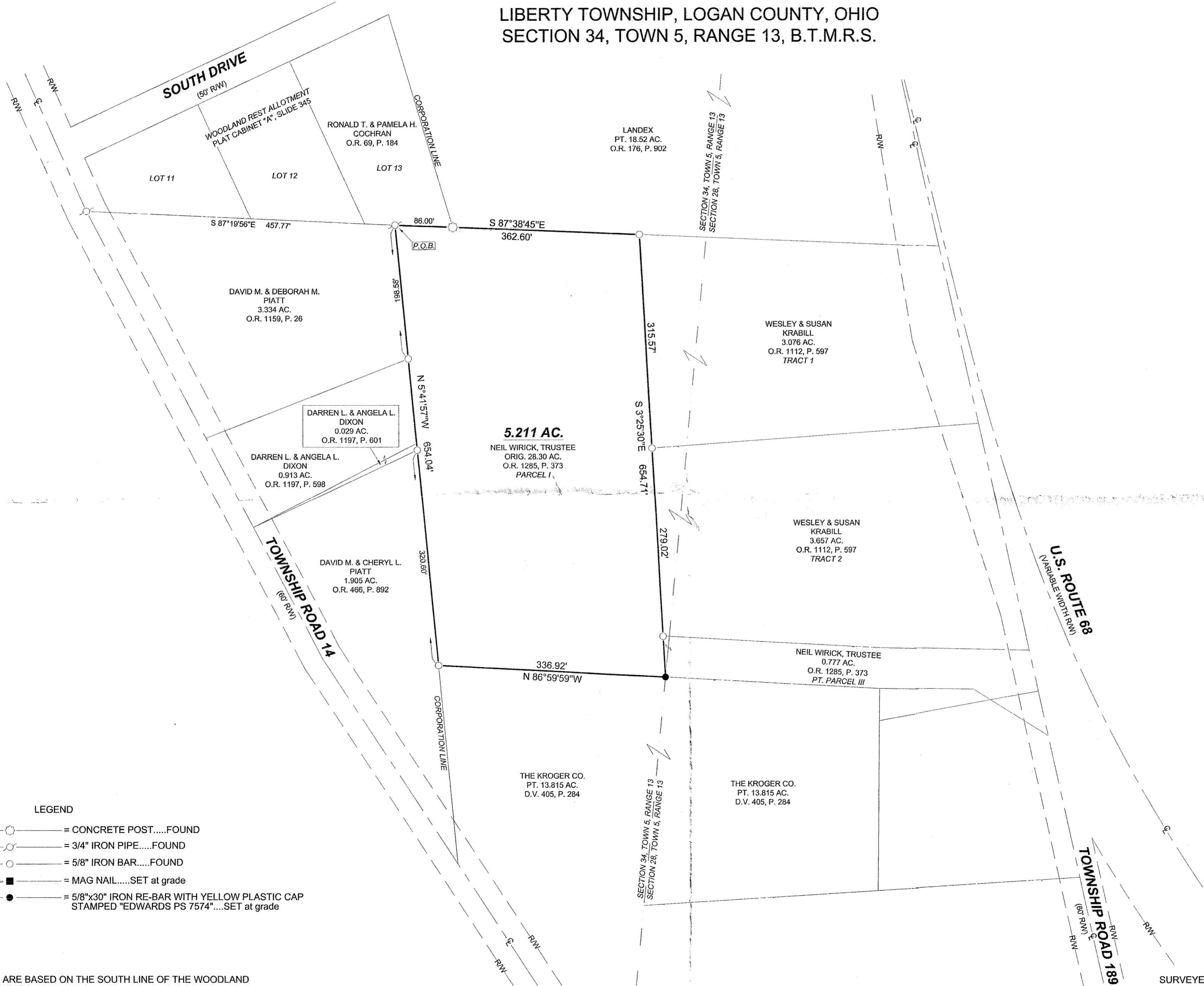
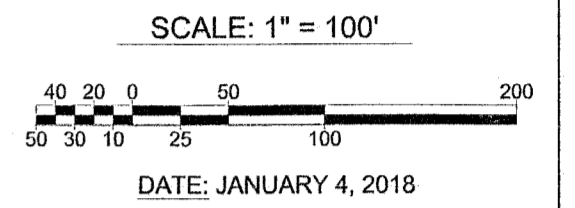
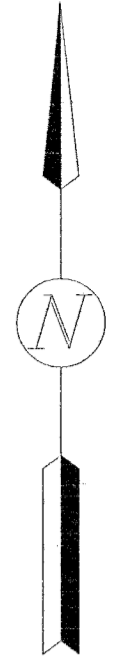

- LEGEND**
- = CONCRETE POST.....FOUND
 - = 3/4" IRON PIPE.....FOUND
 - = 5/8" IRON BAR.....FOUND
 - = MAG NAIL.....SET at grade
 - = 5/8"x30" IRON RE-BAR WITH YELLOW PLASTIC CAP STAMPED "EDWARDS PS 7574".....SET at grade

NOTE:

1. BEARINGS ARE BASED ON THE SOUTH LINE OF THE WOODLAND REST ALLOTMENT SUBDIVISION PER A BEARING OF S-87°19'56"-E.
2. REFERENCES USED: DEED OF SUBJECT PREMISES, DEEDS OF ADJOINING PARCELS, PLATS OF SURVEYS IN THE VICINITY, COUNTY TAX AND AERIAL MAPS, RECORD PLAT OF WOODLAND REST ALLOTMENT - PLAT CABINET "A", SLIDE 345.



SURVEYED BY: *William D. Edwards*
 WILLIAM D. EDWARDS
 PROFESSIONAL SURVEYOR No. 7574
 110 SOUTH MAIN STREET
 URBANA, OHIO 43078
 (937)653-6508

INDEXED ON MAP
2929