

February, 1979

The following described tract of land is situated in the State of Ohio, County of Logan, Township of Jefferson, Village of Zanesfield, V.M.S. #3137, being the intended 0.43 acre parcel described in Deed Volume 358, Page 32, Logan County Recorder's Office, being more particularly described as follows:

Beginning, for reference, at the intersection of the northerly right of way line of County Road #10 (Bristol Ridge Pike) with the easterly right of way line of Sandusky Street;

thence North 14° 00' East 408.50 feet, following the easterly right of way line of Sandusky Street, to an iron pin set at the northwesterly corner of Phyllis Jean Reams Rash's 1.70 acre tract, and at the southwest-erly corner of said 0.43 acre tract, said pin marking the principal place of beginning;

thence North 14° 00' East 68.72 feet, continuing along the easterly right of way line of said Street, to an iron pin set at the northwesterly corner of said 0.43 acre tract and at the southwest-erly corner of Ralph C. Keller's (etux) 0.425 acre tract;

thence South 74° 29' East 190.35 feet, following the southerly line of said 0.425 acre tract and the northerly line of said 0.43 acre tract, to an iron pin set in a westerly line of said 1.70 acre tract;

thence South 16° 51' West 68.00 feet, following a westerly line of said 1.70 acre tract and the easterly line of said 0.43 acre tract, to an iron pin set at the southeasterly corner of said 0.43 acre tract;

thence North 74° 42' West 186.96 feet, following the southerly line of said 0.43 acre tract and the northerly line of said 1.70 acre tract, to the principal place of beginning, containing 0.30 acre, more or less, and subject to all valid easements or restrictions of record.

The northerly line of the above described 0.30 acre tract and the south-erly line of said 0.425 acre tract (0.30 acre actual) is agreed upon here- after as being the common boundary for each parcel as witnessed by the voluntary signing below of the current owners. This agreement is binding upon successors in title to said parcels.

Jan Dudgeon
Witness

Ralph C. Keller Sr
Ralph C. Keller, Sr. 1/2 Interest
D.V. 371, Page 699

Richard W Rash
Witness

Glendora M. Keller
Glendora M. Keller, 1/2 Interest
D.V. 371, Page 699

Gary M. Robson
Witness

George W Reams
George W. Reams, D.V. 358, Page 32

The southerly line of the above described 0.30 acre tract and the northerly line of said 1.70 acre tract (1.023 acre actual) is agreed upon hereafter as being the common boundary for each parcel as witnessed by the voluntary signing below of the current owners. This agreement is binding upon successors in title to said parcels.

Gary M Robson
Witness

George W Reams
George W. Reams, D.V. 358, Pg.32

Dianne K. Reams
Witness

Phyllis Jean Reams Rash
Phyllis Jean Reams Rash, D.V.255
Page 114

The above description was prepared by and from a survey completed in February of 1979 by Paul R. Clapsaddle, R.S. #6140.

ATTEST: Paul R. Clapsaddle, R.S. #6140
Paul R. Clapsaddle, R.S. #6140

LAND SURVEYING AND PLANNING,

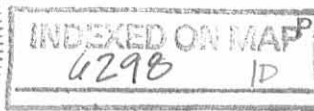

PAUL R. CLAPSADDLE & ASSOCIATES
PROFESSIONAL LAND SURVEYORS
PROFESSIONAL ENGINEERS

PAUL R. CLAI

P. O. Box 184
EAST LIBERTY, OHIO



SURVEY FOR GEORGE W. REAMS

State of Ohio
County of Logan
Township of Jefferson
Village of Zanesfield
V.M.S. 3137
Ref. D.V. 358 Pg. 32
LAND SURVEYING AND PLANNING



6298 IP
INDEXED ON MAP



PAUL R. CLAPSADDLE & ASSOCIATES
PROFESSIONAL LAND SURVEYORS
PROFESSIONAL ENGINEERS

ATTEST: Paul R. Clapsaddle R.S. #6140

SURVEY FOR RALPH C. KELLER, SR.

February 1979

The following described tract of land is situated in the State of Ohio, County of Logan, Township of Jefferson, Village of Zanesfield, V.M.S. 3137, being the intended 0.425 acre parcel described in Deed Volume 371, Page 699, Logan County Recorder's Office, being more particularly described as follows:

Beginning, for reference, at the intersection of the northerly right of way line of County Road #10 (Bristol Ridge Pike) with the easterly right of way line of Sandusky Street;

thence North 14° 00' East 477.22 feet, following the easterly right of way line of Sandusky Street, to an iron pin set at the northwesterly corner of George W. Reams' 0.43 acre tract and at the southwesterly corner of said 0.425 acre tract, said iron pin marking the principal place of beginning;

thence North 14° 00' East 77.50 feet, continuing along the easterly right of way line of said Street, to an iron pin set at the northwesterly corner of said 0.425 acre tract and in the southerly line of Florence Pennock's 44.61 acre tract;

thence South 69° 02' East 194.65 feet, following the southerly line of said 44.61 acre tract and the northerly line of said 0.425 acre tract, to a wood corner post at a northwesterly corner of Phyllis Jean Reams Rash's 1.70 acre tract;

thence South 16° 51' West 59.00 feet, following a westerly line of said 1.70 acre tract and the easterly line of said 0.425 acre tract, to an iron pin set at the northeasterly corner of said 0.43 acre tract;

thence North 74° 29' West 190.35 feet, following the northerly line of said 0.43 acre tract and the southerly line of said 0.425 acre tract, to the principal place of beginning, containing 0.30 acre, more or less, and subject to all valid easements or restrictions of record.

The southerly line of the above described 0.30 acre tract and the northerly line of said 0.43 acre tract (0.30 acre actual) is agreed upon hereafter as being the common boundary for each parcel as witnessed by the voluntary signing below of the current owners. This agreement is binding upon successors in title to said parcels.

Jan Dudgeon
Witness

Ralph C. Keller Sr
Ralph C. Keller, Sr. 1/2 Interest
D.V. 371, Page 699

Richard W Rash
Witness

Glendora M Keller
Glendora M. Keller 1/2 Interest
D.V. 371, Page 699

Gary M. Robinson
Witness

George W. Reams
George W. Reams, D.V. 358, Page 32

The above description was prepared by and from a survey completed in February of 1979 by Paul R. Clapsaddle, R.S. #6140.

ATTEST: Paul R. Clapsaddle R.S. #6140
Paul R. Clapsaddle, R.S. #6140

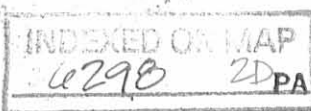

LAND SURVEYING AND PLANNING



PAUL R. CLAPSADDLE & ASSOCIATES
PROFESSIONAL LAND SURVEYORS
PROFESSIONAL ENGINEERS

PAUL R. CLAPSADDLE
RES: (513) 666-4802

P. O. Box 184
EAST LIBERTY, OHIO
OFFICE: (614) 460-2601

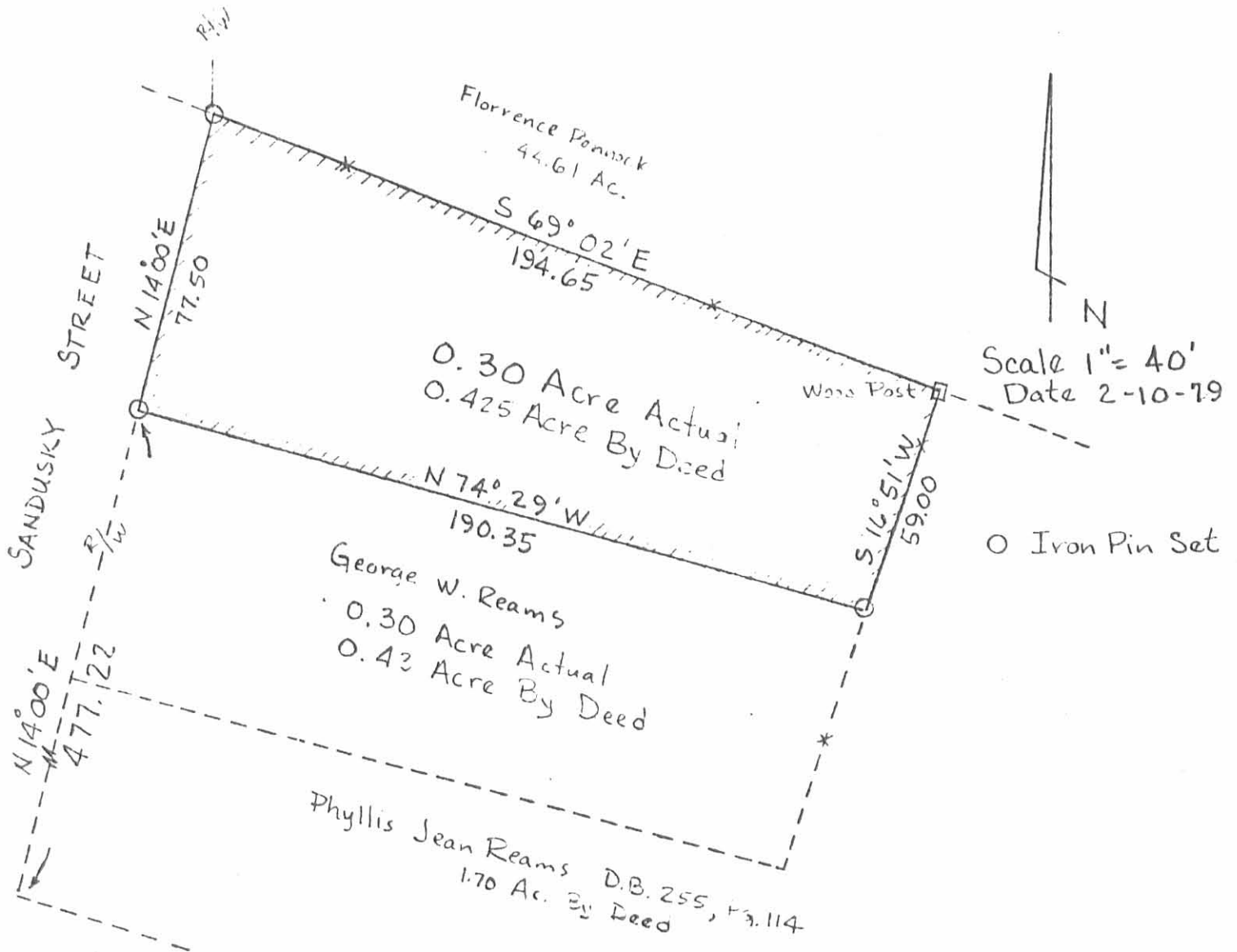

COUNTY RD. # 10
(BRISTOL RIDGE PIKE)

SURVEY FOR RALPH C. KELLER, SR.
State of Ohio
County of Logan
Township of Jefferson
Village of Zanesfield
V.M.S. 3137
Ref D.V. 371, Pg. 699



6298 2P

INDEXED ON MAP

LAND SURVEYING AND PLANNING



PAUL R. CLAPSADDLE & ASSOCIATES
PROFESSIONAL LAND SURVEYORS
PROFESSIONAL ENGINEERS

ATTEST: Paul R. Clapsaddle R.S.#6140

4-19-2021



APPROVED



ARCHITECTURE • ENGINEERING • PLANNING
SURVEYING • CONSTRUCTION SERVICES

INNOVATIVE IDEAS
EXCEPTIONAL DESIGN
UNMATCHED CLIENT SERVICE

SHUMAN 0.610 ACRE

Lying in Virginia Military Survey 3137, Village of Zanesfield, Jefferson Township, Logan County, Ohio (all records referenced herein refer to the Logan County Records of Deeds).

Being all of the Dawn Shuman 0.30 acre tract as deeded and described in Official Record 1275, Page 177 and all of the Dawn Shuman and Adrienne Boysel 0.30 acre tract as deeded and described in Official Record 1396, Page 1268 and being more particularly described as follows:

COMMENCING at a 5/8 inch iron rod found in a monument box at Station 381+31.31 (Logan County Engineer's Field Book 710, Page 17) on the center-line of Sandusky Street (60 feet wide);

THENCE, with the center-line of said Street, N 14°-21'-12" E, a distance of 371.17 feet to a point;

THENCE, within the right-of-way of said Street, S 73°-44'-11" E, passing a 5/8 inch iron rebar found at a distance of 29.36 feet, a total distance of 30.02 feet to a point on the easterly right-of-way of said Street and being a westerly corner common to said Shuman 0.30 acre tract and the Jennifer L. Oelker and Toby Oelker 1.001 acre tract as deeded and described in Official Record 943, Page 429 at the **TRUE POINT OF BEGINNING**;

THENCE, with said easterly right-of-way lines and westerly lines of said Shuman 0.30 acre and Shuman and Boysel 0.30 acre tracts, the following two (2) courses:

1. N 14°-21'-12" E, a distance of 6.00 feet to a 12 inch pine tree at a point of curvature; and
2. With a curve to the left, having a delta angle of 10°-59'-41", a radius of 746.59 feet, an arc length of 143.27 feet, a chord bearing and distance of N 08°-51'-21" E, 143.05 feet to a point on a westerly corner common to said Shuman and Boysel 0.30 acre tract and the Don W. Fraser, Trustee, 70.213 acre tract as deeded and described in Official Record 1384, Page 703 and being on a northerly line of the Zanesfield Corporation Line;

INDEXED ON MAP
6298

117 N Madriver St, Bellefontaine, OH 43311 | OFFICE 937.593.7335 | ONLINE WWW.DLZ.COM

Akron Bellefontaine Bridgeville Burns Harbor Chicago Cincinnati Cleveland Columbus Detroit Flint Fort Wayne Indianapolis Joliet
Kalamazoo Lansing Lexington Louisville Madison Melvindale Munster Muskegon Pittsburgh Port Huron Saint Joseph South Bend Toledo
Waterford



INNOVATIVE IDEAS
EXCEPTIONAL DESIGN
UNMATCHED CLIENT SERVICE

THENCE, with the common line to said 0.30 acre and 70.213 acre tracts and said Corporation Line, **S 67°-59'-50" E**, passing a 5/8 inch iron rebar found at a distance of 1.23 feet, a total distance of **209.03 feet** to an iron rebar set at a corner common to said 0.30 acre and 1.001 acre tracts, referenced by a 5/8 inch iron rebar found bearing S 67°-59'-50" E, a distance of 2.06 feet;

THENCE, with a line common to said 0.30 acre and 1.001 acre tracts, **S 17°-57'-32" W**, passing a 5/8 inch iron rebar found at a distance of 2.00 feet, a total distance of **59.34 feet** to a 5/8 inch iron rebar found at a corner common to both 0.30 acre tracts;

THENCE, with lines common to said Shuman 0.30 acre and 1.001 acre tracts, the following two (2) courses:

1. **S 17°-57'-32" W**, a distance of **67.66 feet** to an iron rebar set; and
2. **N 73°-44'-11" W**, a distance of **185.58 feet** to the **POINT OF BEGINNING**.

Containing **0.610 acre**, more or less.

Iron rebar set, where indicated, are 30 inches in length, 5/8 inch in diameter with a plastic I.D. cap stamped "DLZ OHIO INC."

Property is subject to any and all previous easements and rights-of-way of record.

Bearings and distances, described herein, are derived from GPS observations based on Grid North, Ohio State Plane Coordinate System, North Zone, NAD83 (2011, Epoch 2010), with the center-line of Sandusky Street between Station 381+31.31 and Station 385+96.10, having a bearing of N 14°-21'-12" E. Distances are expressed in U.S. Survey Feet. All other measurements are from angles and distances measured in a field survey by DLZ Ohio, Inc. on April 9, 2021.

Description prepared by:

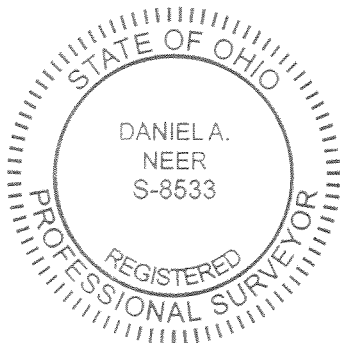

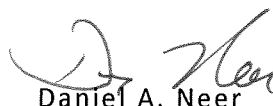

Daniel A. Neer
Professional Surveyor No. 8533
April 9, 2021



2121-2043.00

117 N Madriver St, Bellefontaine, OH 43311 | OFFICE 937.593.7335 | ONLINE WWW.DLZ.COM

4-19-2021



LEGEND:

- 5/8 INCH IRON REBAR FOUND IN MONUMENT BOX
- 5/8 INCH IRON REBAR FOUND
- 5/8 INCH BY 30 INCH IRON REBAR SET WITH PLASTIC I.D. CAP STAMPED "DLZ OHIO INC."
- P.O.C. = POINT OF COMMENCEMENT
- P.O.B. = POINT OF BEGINNING
- R/W = RIGHT-OF-WAY
- C/L = CENTER-LINE
- O.R. = OFFICIAL RECORD
- PG. = PAGE
- X— DENOTES FENCE LINE

OCCUPATION NOTE:

NO EVIDENCE OF OCCUPATION ALONG BOUNDARY LINES UNLESS OTHERWISE SHOWN

BASIS FOR BEARINGS:

BEARINGS AND DISTANCES, SHOWN HEREON, ARE DERIVED FROM GPS OBSERVATIONS BASED ON GRID NORTH, OHIO STATE PLANE COORDINATE SYSTEM, NORTH ZONE, NAD83 (2011, EPOCH 2010), WITH THE CENTER-LINE OF SANDUSKY STREET BETWEEN STATION 381+31.31 TO STATION 385+96.10, HAVING A BEARING OF N 14°-21'-12" E.

THIS SURVEY WAS PREPARED IN THE ABSENCE OF A COMPLETE AND ACCURATE TITLE SEARCH AND DOES NOT GUARANTEE TITLE.

COPYRIGHT 2021 BY:



117 N. Madriver Street • Bellefontaine, OH 43311
(937) 593-7335 • www.dlz.com
Project #2121-2043.00

DEED & SURVEY REFERENCES:

REFERENCE DEEDS ARE SHOWN HEREON

LOGAN COUNTY ENGINEER'S MAP ROOM FILES:

- L-24
- X-25
- 4428, 6298 AND 6645

P.O.C. P.I. STATION 381+31.31
(LOGAN COUNTY ENGINEER'S FIELD BOOK 710, PAGE 17)

P.I. STATION 385+96.10
(LOGAN COUNTY ENGINEER'S FIELD BOOK 710, PAGE 19)

P.I. STATION 392+48.90
(LOGAN COUNTY ENGINEER'S FIELD BOOK 710, PAGE 19)

CURVE	DELTA ANGLE	RADIUS	ARC LENGTH	CHORD BEARING	CHORD LENGTH
C1	10°59'41"	746.59'	143.27'	N 08°51'21" E	143.05'

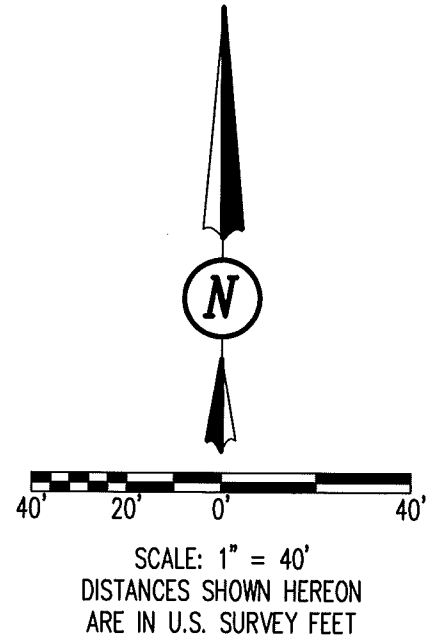
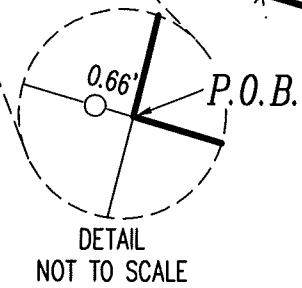
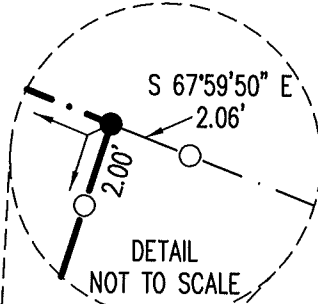
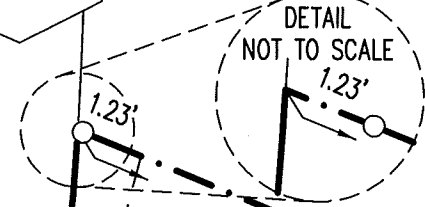
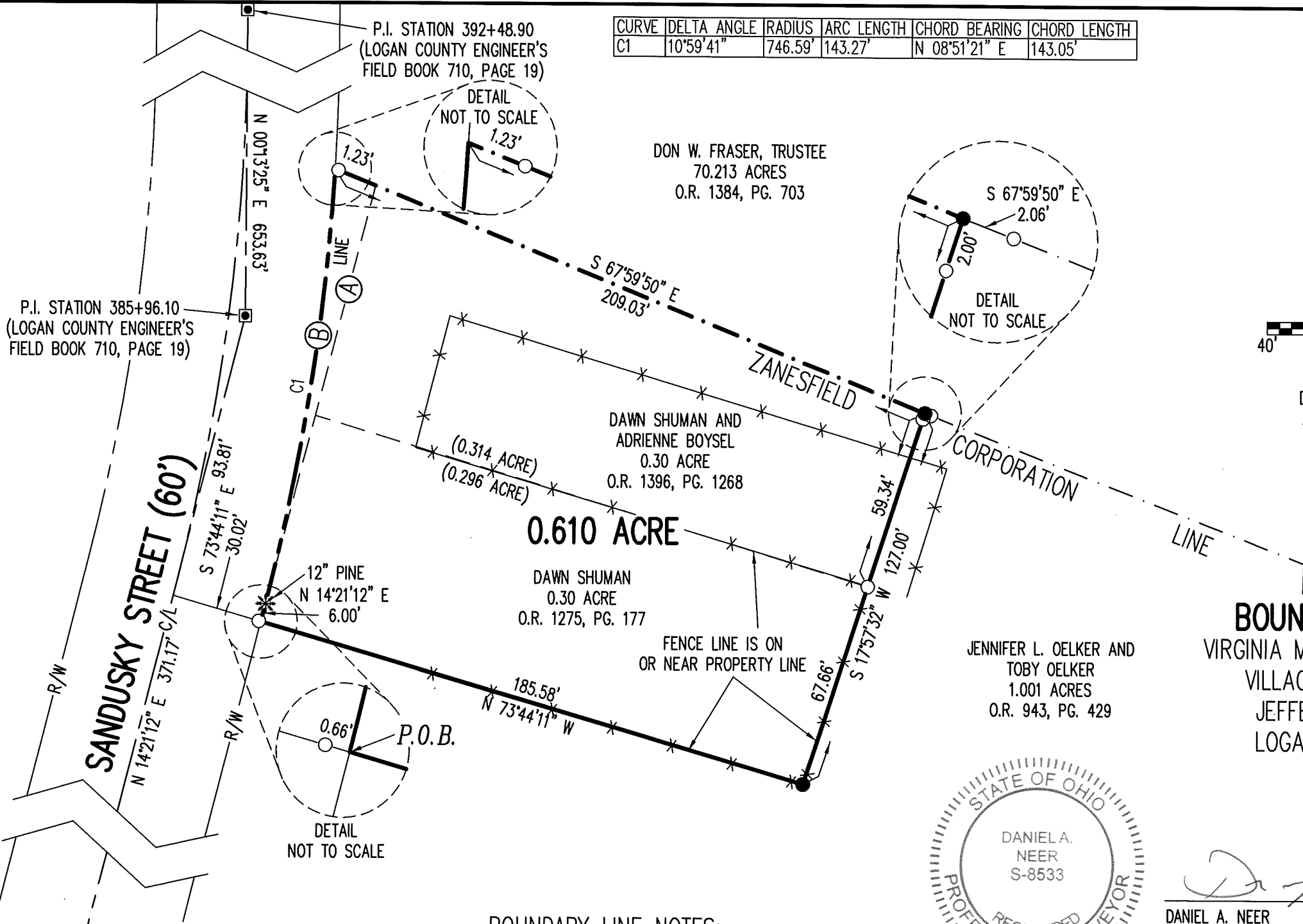

BOUNDARY LINE NOTES:

- Ⓐ LINE PER MOST RECENT DEED.
 - Ⓑ LINE PER O.D.O.T. PLAN (L-24) & X-25 (LOGAN COUNTY ENGINEER'S ATTEMPT TO CLARIFY AMBIGUITY OF R/W LOCATION - PER DISCUSSION WITH LOGAN COUNTY ENGINEER'S OFFICE ON APRIL 8, 2021) ALL DEEDS RESEARCHED FOR THESE PROPERTIES CALL FOR THE EAST SIDE OF SANDUSKY STREET;
- HELD Ⓑ ABOVE.

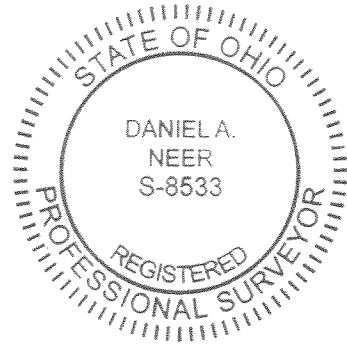

D. Neer
DANIEL A. NEER
PROFESSIONAL SURVEYOR NO. 8533
APRIL 9, 2021

BOUNDARY SURVEY
VIRGINIA MILITARY SURVEY 3137
VILLAGE OF ZANESFIELD
JEFFERSON TOWNSHIP
LOGAN COUNTY, OHIO

DRAWN BY:	DESCRIPTION	REV. NO.	DATE
KSS			4/9/2021

INDEXED ON MAP

6298