

Received 8/20/98 my OK ✓

**SURVEY FOR MELVIN DOUGLAS
1.847 ACRES
AUGUST 19, 1998**

The following described tract of land is situated in the State of Ohio, County of Logan, Township of Perry, V.M.S. 5088, being part of Melvin A. and Ruth Douglas' Tract I, 40.00 acres, described in Official Record 214, page 608, and being more particularly described as follows:

Beginning for reference at a PK nail set at the intersection of the centerline of County Road #10 (60 feet wide) with the southwest line of said V.M.S. 5088;

Thence **South 72°15'44" East (assumed bearing) 499.23 feet**, departing from the southwest line of said V.M.S. 5088 and following the centerline of County Road #10, to a 5/8 inch iron pin found and referenced as Station 86+00 in Logan County Engineers field book 615, page 12;

Thence **South 73°00'00" East 841.03 feet**, following the centerline of County Road #10, passing at 51.00 feet a railroad spike found at the north corner of said 40.00 acre tract, following the northeast line of said 40.00 acre tract thereafter, to a railroad spike set and marking the **place of beginning**;

Thence **South 73°00'00" East 306.97 feet**, continuing along the centerline of County Road #10 and the northeast line of said 40.00 acre tract, to a railroad spike set;

Thence **South 11°56'44" West 214.11 feet**, departing from the centerline of County Road #10 and entering said 40.00 acre tract, passing at 30.12 feet an iron pin set, to an iron pin set;

Thence **South 78°57'52" West 107.27 feet** to an iron pin set;

Thence **North 72°40'09" West 224.37 feet** to an iron pin set;

Thence **North 15°31'10" East 262.48 feet**, passing at 232.47 feet an iron pin set, to the **place of beginning, containing 1.847 acres**, more or less, and subject to all valid easements and restrictions of record.

Of the above described 1.847 acre tract, 0.212 acres are within the road right-of-way of County Road #10.

The above description was prepared from an actual field survey made under the supervision of Paul R. Clapsaddle, Registered Surveyor #6140 during the month of August 1998. Iron pins set are 5/8" by 30" reinforcing rods with caps marked "CLAPSADDLE RS #6140." Bearings indicated hereon are based on an assumed meridian and are to denote angles only.

ATTEST: Paul R. Clapsaddle

Paul R. Clapsaddle, R.S. #6140
19019 West Darby Road
Marysville, Ohio 43040
(937) 747-2599



INDEXED ON MAP
9209 1D-1

Received 8/20/98 SMY OK

**SURVEY FOR MELVIN DOUGLAS
1.543 ACRES
AUGUST 19, 1998**

The following described tract of land is situated in the State of Ohio, County of Logan, Township of Perry, V.M.S. 5088, being part of Melvin A. and Ruth Douglas' Tract I, 40.00 acres, described in Official Record 214, page 608, and being more particularly described as follows:

Beginning for reference at PK nail set at the intersection of the centerline of County Road #10 (60 feet wide) with the southwest line of said V.M.S. 5088;

Thence **South 72°15'44" East (assumed bearing) 499.23 feet**, departing from the southwest line of said V.M.S. 5088 and following the centerline of County Road #10, to a 5/8 inch iron pin found and referenced as Station 86+00 in Logan County Engineers field book 615, page 12;

Thence **South 73°00'00" East 584.15 feet**, following the centerline of County Road #10, passing at 51.00 feet a railroad spike found at the north corner of said 40.00 acre tract, following the northeast line of said 40.00 acre tract thereafter, to a railroad spike set and marking the **place of beginning**;

Thence **South 73°00'00" East 256.88 feet**, continuing along the centerline of County Road #10 and the northeast line of said 40.00 acre tract, to a railroad spike set;

Thence **South 15°31'10" West 262.48 feet**, departing from the centerline of County Road #10 and entering said 40.00 acre tract, passing at 30.01 feet an iron pin set, to an iron pin set;

Thence **North 72°40'09" West 256.92 feet** to an iron pin set;

Thence **North 15°31'10" East 261.00 feet**, passing at 230.99 feet an iron pin set, to the **place of beginning, containing 1.543 acres**, more or less, and subject to all valid easements and restrictions of record.

Of the above described 1.543 acre tract, 0.177 acres are within the road right-of-way of County Road #10.

The above description was prepared from an actual field survey made under the supervision of Paul R. Clapsaddle, Registered Surveyor #6140 during the month of August 1998. Iron pins set are 5/8" by 30" reinforcing rods with caps marked "CLAPSADDLE RS #6140." Bearings indicated hereon are based on an assumed meridian and are to denote angles only.

ATTEST: Paul R. Clapsaddle
Paul R. Clapsaddle, R.S. #6140
19019 West Darby Road
Marysville, Ohio 43040
(937) 747-2599



INDEXED ON MAP
9209 10-2

SURVEY FOR MELVIN DOUGLAS

State of Ohio, County of Logan, Township of Perry, V.M.S. 5088, being part of Melvin A. and Ruth Douglas' Tract I, 40.00 acres, described in Official Record 214, page 608.

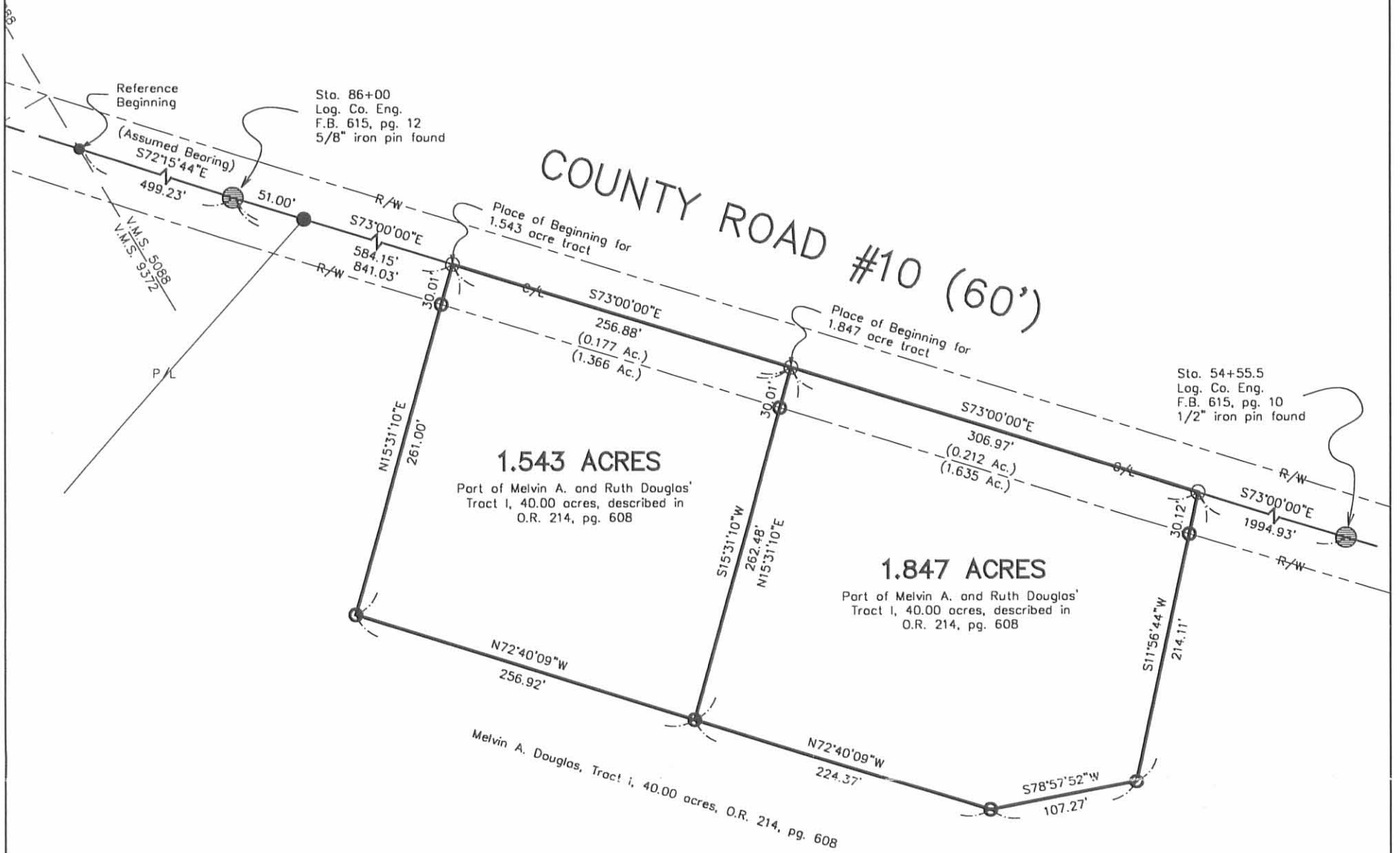

- PK Nail set
- Railroad spike found
- Railroad spike set
- 5/8" iron pin found unless otherwise noted
- 5/8" iron pin set with cap marked "CLAPSADDLE RS #6140"

Reference deeds shown hereon.

Bearings indicated hereon are based on an assumed meridian with all others based on angles turned.

I hereby certify that this plot was prepared from an actual field survey made under my supervision and that monuments were placed as indicated hereon.

Paul R. Clapsaddle
Paul R. Clapsaddle, R.S. #6140



INDEXED ON MAP
92091P



Paul R. Clapsaddle and Associates
REGISTERED ENGINEERS AND SURVEYORS
19019 WEST DARBY ROAD, MARYSVILLE OHIO 43040
(513) 747-2599
(800) 745-2599
Paul R. Clapsaddle, P.E., P.S.

Filename: Dugls898.dwg
Scale: 1" = 100'
Date: 8/19/98

4-5-14

Lee Surveying and Mapping Co., Inc.

Land Surveys • Topography • Subdivisions • Construction Layout



Phone: (937) 593-7335
Fax: (937) 593-7444
surveys@lsminc.us

DOUGLAS 1.838 ACRES

Lying in Virginia Military Survey 5088, Perry Township, Logan County, Ohio.

Being out of the Melvin A. Douglas and Ruth Douglas 38.457 acre tract as deeded and described in Official Record 1145, Page 330, Tract I of the Logan County Records of Deeds and being more particularly described as follows:

Commencing on a 5/8 inch iron rod found on the center-line of County Highway 10 at Station 86+00 (Logan County Engineer's Field Book 615, Pg. 12).

THENCE, with the center-line of County Highway 10 (60 feet wide), S 73°-00'-00"E, a distance of 1147.84 feet to a railroad spike found at the TRUE POINT OF BEGINNING.

THENCE, with the center-line of County Highway 10, S 73°-00'-00"E, a distance of 256.27 feet to a MAG nail set.

THENCE, S 17°-20'-08"W, a distance of 353.85 feet to a 5/8 inch iron rod set, passing a 5/8 inch iron rod set at 30.00 feet.

THENCE, N 62°-25'-10"W, a distance of 230.49 feet to a 5/8 inch iron rod set.

THENCE, N 11°-56'-00"E, a distance of 312.74 feet to the point of beginning, passing 5/8 inch iron rods found at 98.66 feet and 282.62 feet.

Containing 1.838 acres, of which 0.176 acre is within the highway right-of-way.

Property is subject to any and all previous easements and rights-of-way of record.

The basis for bearings is the center-line of County Highway 10, being S 73°-00'-00"E, and all other bearings are from angles and distances measured in a field survey by Lee Surveying and Mapping Co., Inc. on March 26, 2016.



ORIGINAL STAMP IN GREEN

Description prepared by:

William K. Bruce
Professional Surveyor 7437
March 28, 2016

60720216

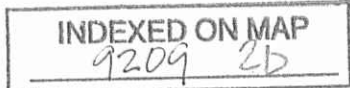

APPROVED 4-5-14

STATION 86+00
(LOGAN COUNTY ENGINEER'S
FIELD BOOK 615, PG. 12)

(BASIS FOR BEARINGS)
S 73°00'00" E
1147.84'

COUNTY HIGHWAY 10 (60')
S 73°00'00" E
256.27'

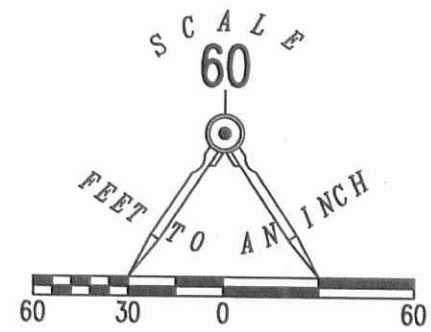

STATION 54+55.5
(LOGAN COUNTY ENGINEER'S
FIELD BOOK 615, PG. 10)

MELVIN A. DOUGLAS
AND RUTH DOUGLAS
38.457 ACRES
O.R. 1145, PG. 330
TRACT I

1.838 ACRES
OF WHICH 0.176 ACRE IS WITHIN
THE HIGHWAY RIGHT-OF-WAY

SURVEY OF 1.838 ACRES OUT OF THE
MELVIN A. DOUGLAS
AND RUTH DOUGLAS
38.457 ACRE TRACT
OFFICIAL RECORD 1145, PAGE 330
TRACT I
VIRGINIA MILITARY SURVEY 5088
PERRY TOWNSHIP
LOGAN COUNTY, OHIO

LEGEND:

- ⊗ RAILROAD SPIKE FOUND
- MAG NAIL SET
- 5/8 INCH IRON ROD FOUND
- 5/8 INCH IRON ROD SET WITH PLASTIC I.D. CAP STAMPED "LSM 7437"

THIS SURVEY WAS PREPARED IN THE ABSENCE OF
A COMPLETE AND ACCURATE TITLE SEARCH AND
DOES NOT GUARANTEE TITLE.

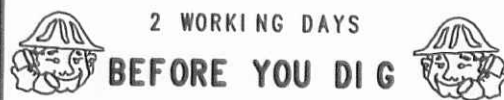

CALL TOLL FREE 800-362-2764
OHIO UTILITIES PROTECTION SERVICE.



SURVEYED BY:
William K. Bruce
WILLIAM K. BRUCE
PROFESSIONAL SURVEYOR 7437
MARCH 26, 2016

COPYRIGHT 2016 BY:
LEE SURVEYING & MAPPING CO., INC.
117 North Madriver Street
BELLEFONTAINE, OHIO 43311
(937) 593-7335
WWW.LSMINC.US
surveys@lsminc.us

KSS D0216 60720216 L-6072-3

INDEXED ON MAP
9209 2P

2-4-2020



SURVEY FOR THE DOUGLAS ESTATE
2.190 Acres
January 6, 2020

The following described 2.190 acre tract is situated in the State of Ohio, County of Logan, Township of Perry, V.M.S. 5088, being part of Melvin A. Douglas and Ruth Douglas' 38.457 acre Tract I described in Official Record 1145, page 330, and said 2.190 acre tract being more particularly described as follows:

Beginning for reference at a 3/8 inch iron pin found in the centerline of County Road 10 (60 feet wide) at Station 86+00 as referenced in Logan County Engineer's Field Book 615, page 12;

Thence South 74°30'05" East (assumed bearing) 840.94 feet, following the centerline of County Road 10, passing at 50.92 feet a railroad spike found at the northwest corner of said 38.457 acre tract and at the northeast corner of Nick Alan Johnson and Sharon Marie Johnson's 13.22 acre tract described in Official Record 114, page 209, passing at 583.49 feet a magnetic nail set, passing at 584.06 feet a railroad spike found at the northwest corner of Roy W. Crites and Vicki D. Crites' 1.543 acre tract described in Official Record 377, page 951, thereafter following the north line of said 1.543 acre tract, to a railroad spike found at the northeast corner of said 1.543 acre tract and at a north corner of original 38.457 acre tract, said spike marking the *place of beginning*;

Thence *South 74°30'05" East 306.89 feet*, following the centerline of County Road 10 and a north line of said 38.457 acre tract, to a railroad spike found;

Thence *South 10°25'58" West 312.74 feet*, departing from the centerline of County Road 10 and entering said 38.457 acre tract, passing at 30.12 feet a 5/8 inch iron pin found, to a 5/8 inch iron pin found with cap marked "LSM PS 7437";

Thence *North 71°00'55" West 327.56 feet*, continuing through said 38.457 acre tract, to an iron pin set;

Thence *North 14°00'55" East 291.70 feet*, continuing through said 38.457 acre tract, passing at 29.23 feet a 5/8 inch iron pin found with cap marked "CLAPSADDLE RS 6140" at the southeast corner of said 1.543 acre tract, thereafter following the east line of said 1.543 acre tract and passing at 261.68 feet a 5/8 inch iron pin found with cap marked "CLAPSADDLE RS 6140", to the *place of beginning, containing 2.190 acres*, more or less, and being subject to all valid easements and restrictions of record. Of the above described 2.190 acre tract, 0.212 acre is within the right of way of County Road 10.

The above description was prepared from a field survey made under the supervision of Paul R. Clapsaddle, Registered Surveyor 6140, during the month of December 2019. Bearings indicated herein are based on an assumed meridian with all others based on angles turned. Iron pins set are 5/8 inch by 30 inch reinforcing rods with caps marked "CLAPSADDLE RS 6140".

ATTEST:

Paul R. Clapsaddle, R.S. 6140
19019 West Darby Road
Marysville, Ohio 43040
(937) 747-2599



INDEXED ON MAP
9209

2-4-2020



SURVEY FOR THE DOUGLAS ESTATE

0.136 Acre

January 6, 2020

The following described 0.136 acre tract is situated in the State of Ohio, County of Logan, Township of Perry, V.M.S. 5088, being part of Melvin A. Douglas and Ruth Douglas' 38.457 acre Tract I described in Official Record 1145, page 330, and said 0.136 acre tract being more particularly described as follows:

Beginning for reference at a 3/8 inch iron pin found on the centerline of County Road 10 (60 feet wide) at Station 86+00 as referenced in Logan County Engineer's Field Book 615, page 12;

Thence South 74°30'05" East (assumed bearing) 583.49 feet, following the centerline of County Road 10, passing at 50.92 feet a railroad spike found at the northwest corner of said 38.457 acre tract and at the northeast corner of Nick Alan Johnson and Sharon Marie Johnson's 13.22 acre tract described in Official Record 114, page 209, thereafter following a north line of said 38.457 acre tract, to a magnetic nail set and marking the *place of beginning*;

Thence *South 74°30'05" East 0.57 feet*, following the centerline of County Road 10 and the north line of said 38.457 acre tract, to a railroad spike found at the northwest corner of Roy W. Crites and Vicki D. Crites' 1.543 acre tract described in Official Record 377, page 951;

Thence *South 14°00'55" West 261.00 feet*, departing from the centerline of County Road 10, following an east line of said 38.457 acre tract and the west line of said 1.543 acre tract, passing at 30.01 feet a 5/8 inch iron pin found with cap marked "CLAPSADDLE RS 6140", to a 5/8 inch iron pin found with cap marked "CLAPSADDLE RS 6140";

Thence *South 74°10'24" East 256.92 feet*, following a north line of said 38.457 acre tract and the south line of said 1.543 acre tract, to a 5/8 inch iron pin found with cap marked "CLAPSADDLE RS 6140"

Thence *South 14°00'55" West 29.23 feet*, entering said 38.457 acre tract, to an iron pin set;

Thence *North 69°25'54" West 266.54 feet*, continuing through said 38.457 acre tract, to an iron pin set;

Thence *North 15°36'20" East 268.05 feet*, continuing through said 38.457 acre tract, passing at 238.04 feet an iron pin set, to the *place of beginning, containing 0.136 acre*, more or less, and being subject to all valid easements and restrictions of record. Of the above described 0.136 acre tract, 0.001 acre is within the right of way of County Road 10.

The above description was prepared from a field survey made under the supervision of Paul R. Clapsaddle, Registered Surveyor 6140, during the month of December 2019. Bearings indicated herein are based on an assumed meridian with all others based on angles turned. Iron pins set are 5/8 inch by 30 inch reinforcing rods with caps marked "CLAPSADDLE RS 6140".

ATTEST:

Paul R. Clapsaddle, R.S. 6140
19019 West Darby Road
Marysville, Ohio 43040
(937) 747-2599



INDEXED ON MAP
9209

2-4-2020

APPROVED

Reference Beginning
Sta. 86+00
F.B. 615, Pg. 12

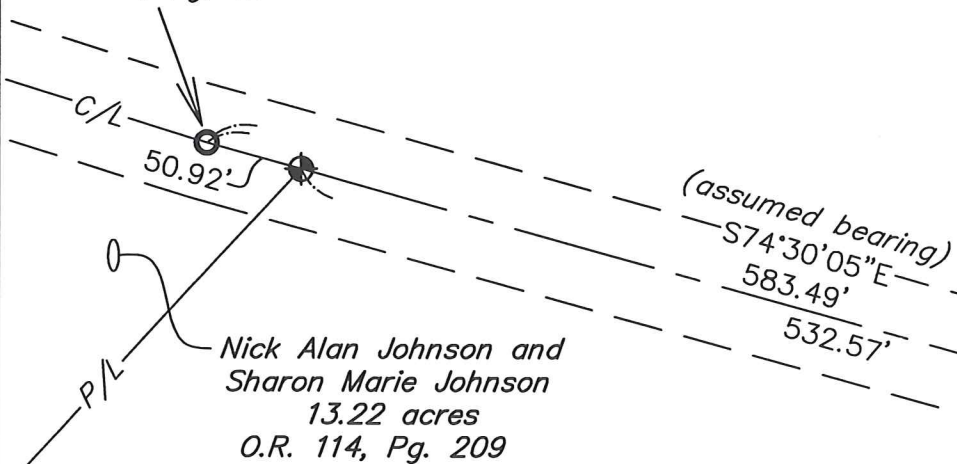

LEGEND:

- ⊕ Railroad spike found
- 5/8 inch iron pin set with cap marked "CLAPSADDLE RS 6140"
- Magnetic nail set
- 5/8 inch iron pin found
- ⊙ 5/8 inch iron pin found with cap marked "CLAPSADDLE RS 6140"
- ⊙ 3/8 inch iron pin found
- ⊙ 5/8 inch iron pin found with cap marked "LSM PS 7437"



DOUGLAS ESTATE SURVEY

STATE OF OHIO, COUNTY OF LOGAN,
TOWNSHIP OF PERRY, V.M.S. 5088

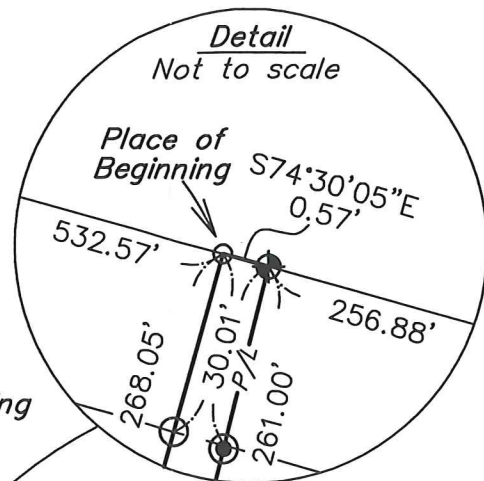

Place of Beginning
0.136 acres

Place of Beginning
2.190 acres

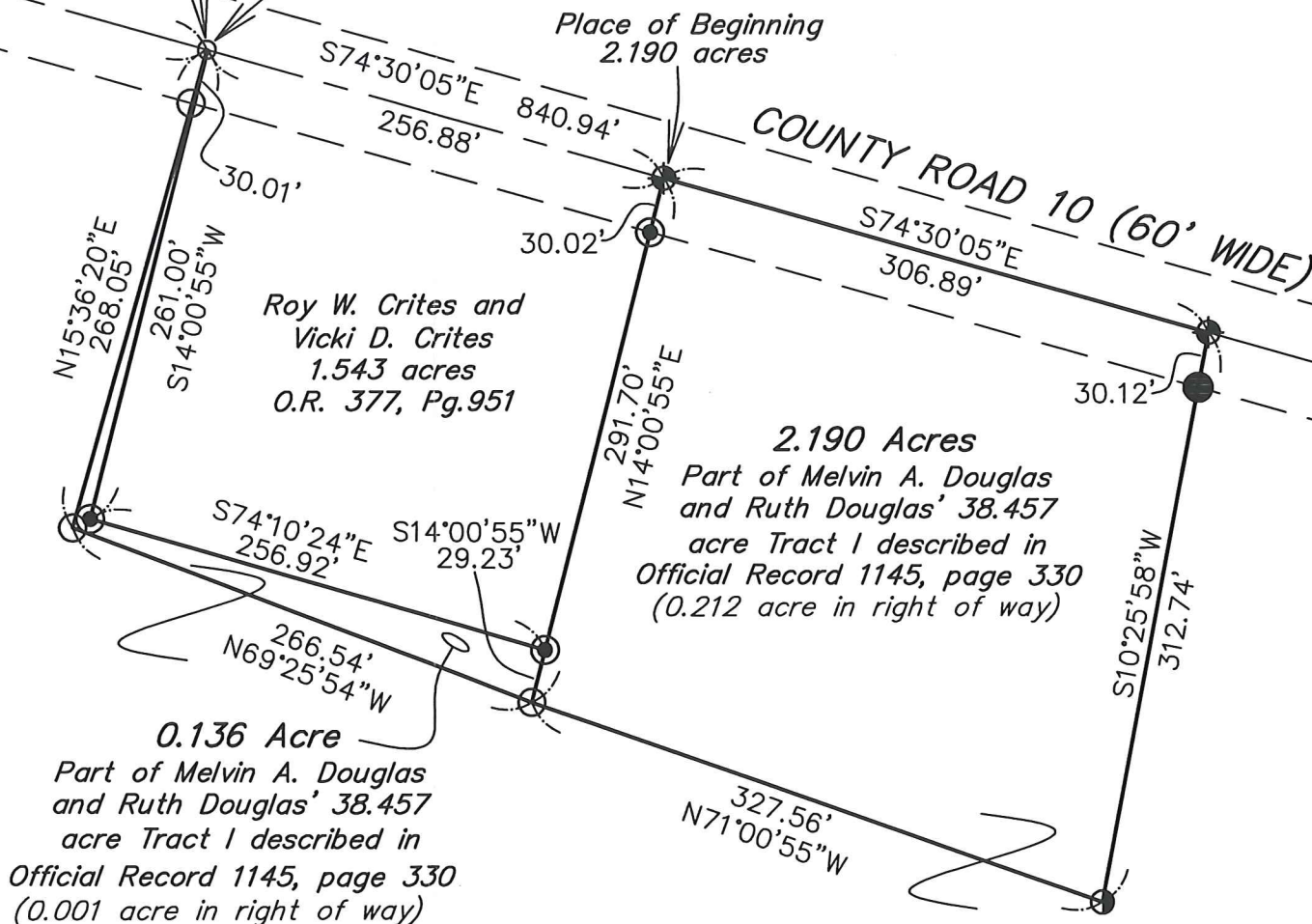

Paul R. Clapsaddle and Associates

REGISTERED ENGINEERS AND SURVEYORS

19019 WEST DARBY ROAD, MARYSVILLE OHIO 43040
(937) 747-2599

Paul R. Clapsaddle, P.E., P.S.

Melvin A. Douglas and Ruth Douglas
38.457 acre Tract I
Official Record 1145, page 330

Date: January 6, 2020
Scale: 1"=100'
Project: Douglas919
Drawing: Douglas1.92&0.136Dec19

I hereby certify that this plat was prepared from an actual field survey made under my supervision and that monuments were placed as indicated hereon.

Paul R. Clapsaddle
Paul R. Clapsaddle, R.S. 6140

INDEXED ON MAP
9209

2-4-2020



**SURVEY FOR THE
DOUGLAS ESTATE
172.572 Acres
January 6, 2020**

The following described 172.572 acre tract is situated in the State of Ohio, County of Logan, Township of Perry, V.M.S. 5088, V.M.S. 4655, and V.M.S. 9198, being part of Melvin A. Douglas and Ruth Douglas' 38.457 acre Tract I, all of 23 acre 3 rods and 31 poles Parcel A of Tract II, all of 17.41 acre Parcel B of Tract II, all of 64.20 acre Tract III, and all of a ½ acre Tract IV, and all of a 32 acre Tract V, all being described in Official Record 1145, page 330, and said 172.572 acre tract being more particularly described as follows:

Beginning for reference at a 3/8 inch iron pin found on the centerline of County Road 10 (60 feet wide) at Station 86+00 as referenced in Logan County Engineer's Field Book 615, page 12;

Thence **South 74°30'05" East** (assumed bearing) 50.92 feet, following the centerline of County Road 10, to a railroad spike found at the northwest corner of said 38.457 acre tract and at the northeast corner of Nick Alan Johnson and Sharon Marie Johnson's 13.22 acre tract described in Official Record 114, page 209, said iron pin marking the *place of beginning*;

Thence **South 74°30'05" East 532.57 feet**, following the centerline of County Road 10 and the north line of said 38.457 acre tract, to a magnetic nail set;

Thence **South 15°36'20" West 268.05 feet**, departing from the centerline of County Road 10 and entering said 38.457 acre tract, passing at 30.01 feet an iron pin set, to an iron pin set;

Thence **South 69°25'54" East 266.54 feet**, continuing through said 38.457 acre tract, to an iron pin set;

Thence **South 71°00'55" East 327.56 feet**, continuing through said 38.457 acre tract, to a 5/8 inch iron pin found with cap marked "LSM PS 7437";

Thence **South 63°55'12" East 230.49 feet**, continuing through said 38.457 acre tract, to a 5/8 inch iron pin found with cap marked "LSM PS 7437";

Thence **North 15°50'06" East 353.85 feet**, continuing through said 38.457 acre tract, passing at 323.86 feet a 5/8 inch iron pin found with cap marked "LSM 7437", to a railroad spike found on the centerline of County Road 10;

Thence **South 74°30'05" East 789.08 feet**, following the centerline of County Road 10, a north line of said 38.457 acre tract, and the north line of said ½ acre tract, to a magnetic nail set in the southeast line of V.M.S. 5088, in the northwest line of V.M.S. 4655, in the northwest line of said 64.20 acre tract, and at the southeast corner of Donald B. Henry, Trustee's and Gloria J. Henry, Trustee's 147.18 acre Tract IV described in Official Record 828, page 578 and Official Record 828, page 584;

Thence **North 55°57'28" East 22.83 feet**, departing from the centerline of County Road 10, following the northwest line of V.M.S. 4655 and said 64.20 acre tract, and following the southeast line of V.M.S. 5088 and said 147.18 acre tract, to an iron pin set at a west corner of Halley M. Ackley and Rebecca A. Ackley's 202.385 acre Tract II described in Official Record 400, page 644;

Thence **South 61°01'08" East 179.52 feet**, entering V.M.S. 4655, following the north line of said 64.20 acre tract, and following a south line of said 202.385 acre tract, passing at 74.49 feet a magnetic nail set on the centerline of County Road 10, to an iron pin set;

INDEXED ON MAP

9209

Thence *South 32°58'52" West 258.72 feet*, following an east line of said 64.20 acre tract and a west line of said 202.385 acre tract, to an iron pin set;

Thence *South 56°10'52" West 33.00 feet*, following a southeast line of said 64.20 acre tract and a northwest line of said 202.385 acre tract, to an 8 inch wood corner post found;

Thence *South 33°21'10" East 1165.26 feet*, following a northeast line of said 64.20 acre tract and a southwest line of said 202.385 acre tract, passing iron pins set at 2.00 feet and at 1163.26 feet, to an 8 inch wood corner post found in the northwest line of Shelly Materials, Inc.'s 260.551 acre tract described in Official Record 1293, page 843;

Thence *South 55°51'56" West 2895.37 feet*, following the southeast line of said 64.20 acre tract, the southeast line of said 32 acre tract, and a northwest line of said 260.551 acre tract, to a broken off 3 inch T-shaped steel post found;

Thence *North 34°15'16" West 2668.82 feet*, following the southwest line of said 32 acre tract, the southwest line of said 64.20 acre tract, and the northeast line of said 260.551 acre tract, passing the northwest line of V.M.S. 4655 and entering V.M.S. 9198, thereafter following the southwest line of said 23 acre 3 rods 31 poles tract, the southwest line of said 17.41 acre tract, and continuing with the northeast line of said 260.551 acre tract, to a magnetic nail set in the northeast side of a 10 inch maple tree at the south corner of said 13.22 acre tract;

Thence *North 42°56'56" East 1740.77 feet*, following the northwest line of said 17.41 acre tract and the southeast line of said 13.22 acre tract, passing the northeast line of V.M.S. 9198, entering V.M.S. 5088, and passing at 1706.47 feet an iron pin set, to the *place of beginning, containing 172.572 acres*, more or less, and being subject to all valid easements and restrictions of record.

Of the above described 172.572 acre tract, 0.907 acre is within the right of way of County Road 10, 41.468 acres are in V.M.S. 9198, 96.498 acres are in V.M.S. 4655, and 34.606 acres are in V.M.S. 5088. Of the above described 172.572 acre tract, 64.448 acres are all of said 64.20 acre tract, 34.097 acres are part of said 38.457 acre tract, 41.468 acres are all of said 17.41 acre tract and said 23 acre 3 rods 31 poles tract, 0.509 acre is all of said ½ acre tract and 32.050 acres are all of said 32 acre tract).

The above description was prepared from a field survey made under the supervision of Paul R. Clapsaddle, Registered Surveyor 6140, during the month of December 2019. Bearings indicated herein are based on an assumed meridian with all others based on angles turned. Iron pins set are 5/8 inch by 30 inch reinforcing rods with caps marked "CLAPSADDLE RS 6140".

ATTEST:



Paul R. Clapsaddle, R.S. #6140
19019 West Darby Road
Marysville, Ohio 43040
(937) 747-2599

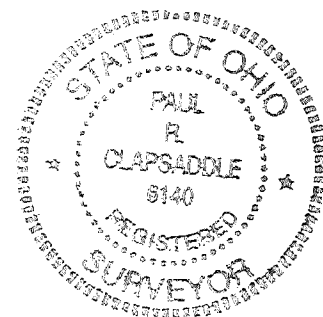

INDEXED ON MAP

9209

DOUGLAS ESTATE SURVEY

STATE OF OHIO, COUNTY OF LOGAN,
TOWNSHIP OF PERRY, V.M.S. 4655,
V.M.S. 5088, AND V.M.S. 9198

NOTES:
Reference deeds are shown hereon
Bearings indicated hereon are based on
an assumed meridian with all others
based on angles turned

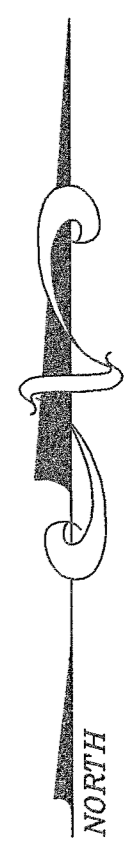

V.M.S. Acreages
V.M.S. 9198 - 41,468 acres
V.M.S. 4655 - 96,498 acres
V.M.S. 5088 - 34,606 acres

Area in each Parcel by this survey:
32-111-00-00-024-000 = 64.447 acres
32-111-00-00-024-001 = 32.051 acres
32-110-00-00-014-000 = 41,468 acres
32-110-00-00-023-000 = 34,097 acres
32-111-00-00-023-001 = 0.509 acre

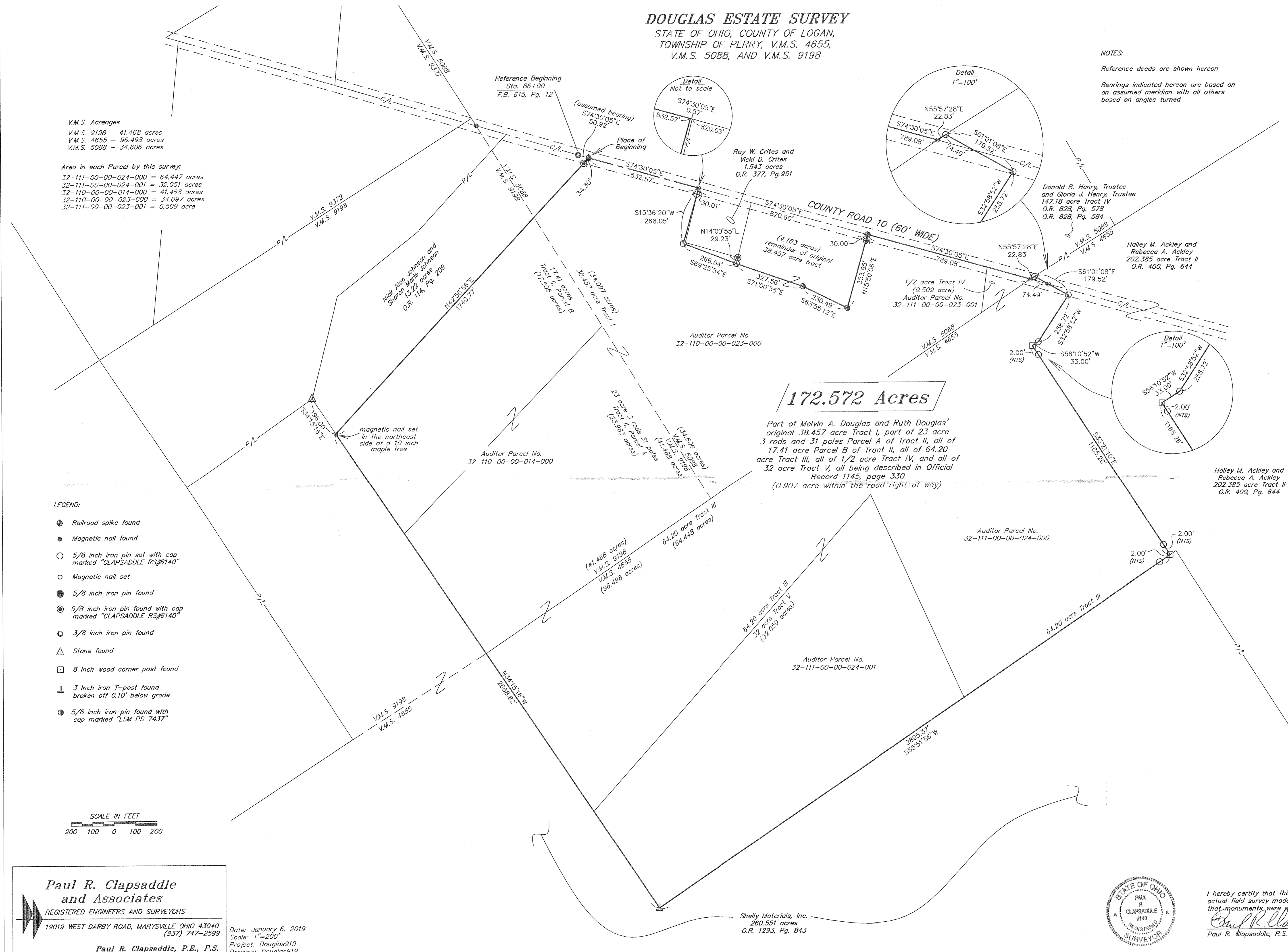

SURVEY REFERENCES:
R-FILE 4239
R-FILE 9209

- LEGEND:
- ◆ Railroad spike found
 - Magnetic nail found
 - 5/8 inch iron pin set with cap marked "CLAPSADDLE RS#6140"
 - Magnetic nail set
 - 5/8 inch iron pin found
 - ⊙ 5/8 inch iron pin found with cap marked "CLAPSADDLE RS#6140"
 - 3/8 inch iron pin found
 - △ Stone found
 - 8 Inch wood corner post found
 - ⊥ 3 Inch iron T-post found broken off 0.10' below grade
 - ⊙ 5/8 inch iron pin found with cap marked "LSM PS 7437"

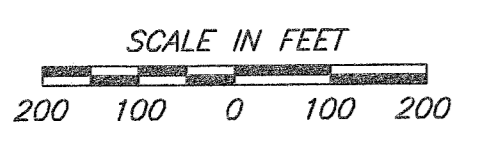

Paul R. Clapsaddle and Associates
REGISTERED ENGINEERS AND SURVEYORS
19019 WEST DARBY ROAD, MARYSVILLE OHIO 43040
(937) 747-2599
Date: January 6, 2019
Scale: 1"=200'
Project: Douglas919
Drawing: Douglas919
Paul R. Clapsaddle, P.E., P.S.



I hereby certify that this plat was prepared from an actual field survey made under my supervision and that monuments were placed as indicated hereon.
Paul R. Clapsaddle
Paul R. Clapsaddle, R.S. #6140